

CIP Training

L5160/L5130

RICOH
imagine. change.

6 Solutions

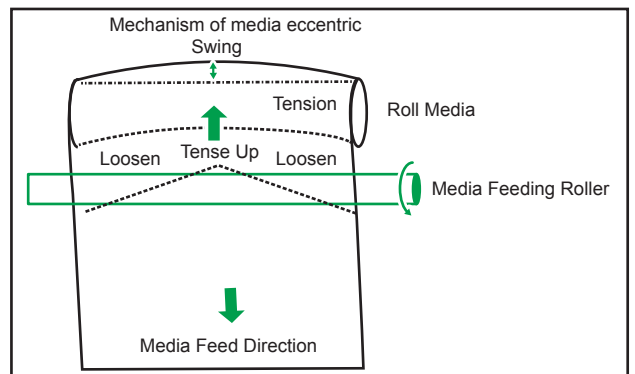
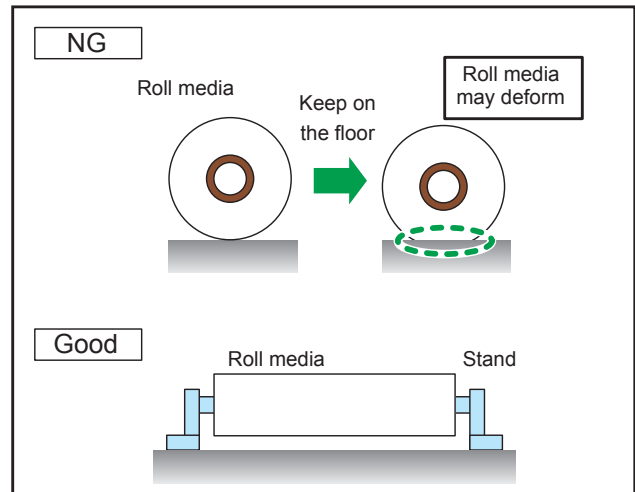

Solutions

Before You Start

How to Read the Manual

This document is a troubleshooting manual to handle abnormal images that may appear in some situations.

In addition, it explains how to identify problem factors and technical mechanisms.

When Print Quality Is Not Satisfactory

Uneven density (Major case)

Uneven density

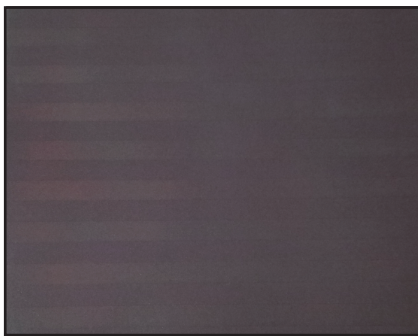

[Cause/Technical reason]

In order to use this device to print properly, load and feed the media correctly. The device with the stagger head configuration may experience unacceptable image quality due to improper media feeding such as skewing.

You can find the factor for uneven density with printed cutter marks. (It does not have to be a cutter mark, small character or thin line is enough to find the factor.)

[Adding registration marks]

Using **ONYX RIP**, you can add registration marks to the job.

The way to add registration marks may vary depending on the version.

"Right click on the job Marks"

- Open the "Job Properties"
- Open the "Marks" tab
- Check the "Edge"

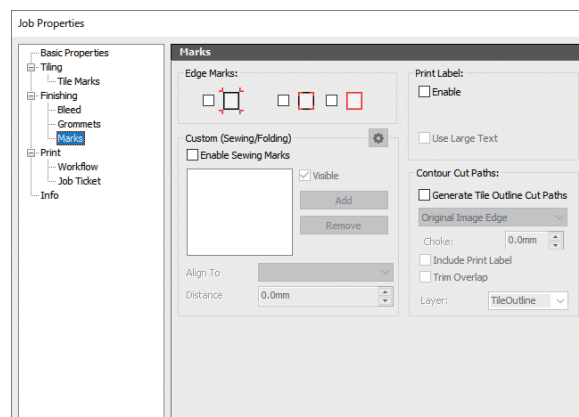

CIP Training L5160/L5130

Solutions

Using the ColorGATE RIP, you can add registration marks to the job. The way to add registration marks may vary depending on the version.

Right click on the job

- Open the "Settings" window
- Open the "Job" tab
- Click on the cut marks icon
- Select "Cut Marks".

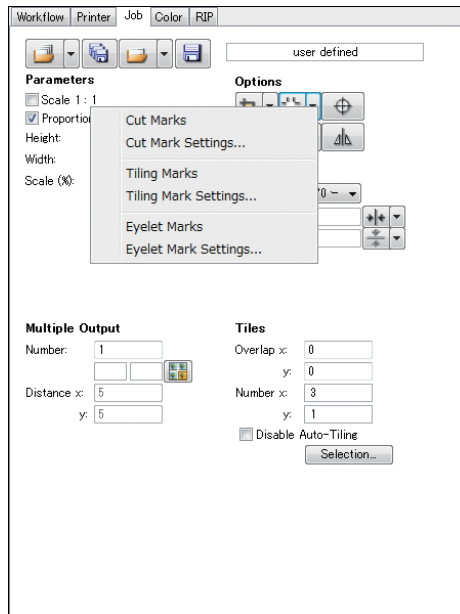

[Details / Solution]

The solution varies depending on the problem. See the corresponding item.

- $a \neq b$
If the registration marks are not on the same level on the right and left positions, the media is skewed. "STEP1-1 If there is skewing"
- $a \approx b \neq 0$
If the registration marks are misaligned in a media feed direction, the media feed quantity is not correct. "STEP1-2 If the media feed quantity is not correct"
- $a \approx b \approx 0$
It is necessary to further adjust the media feed quantity.
"STEP2 Adjust the actual image by Media Feed Adjustment (Micro Setting)"

Solutions

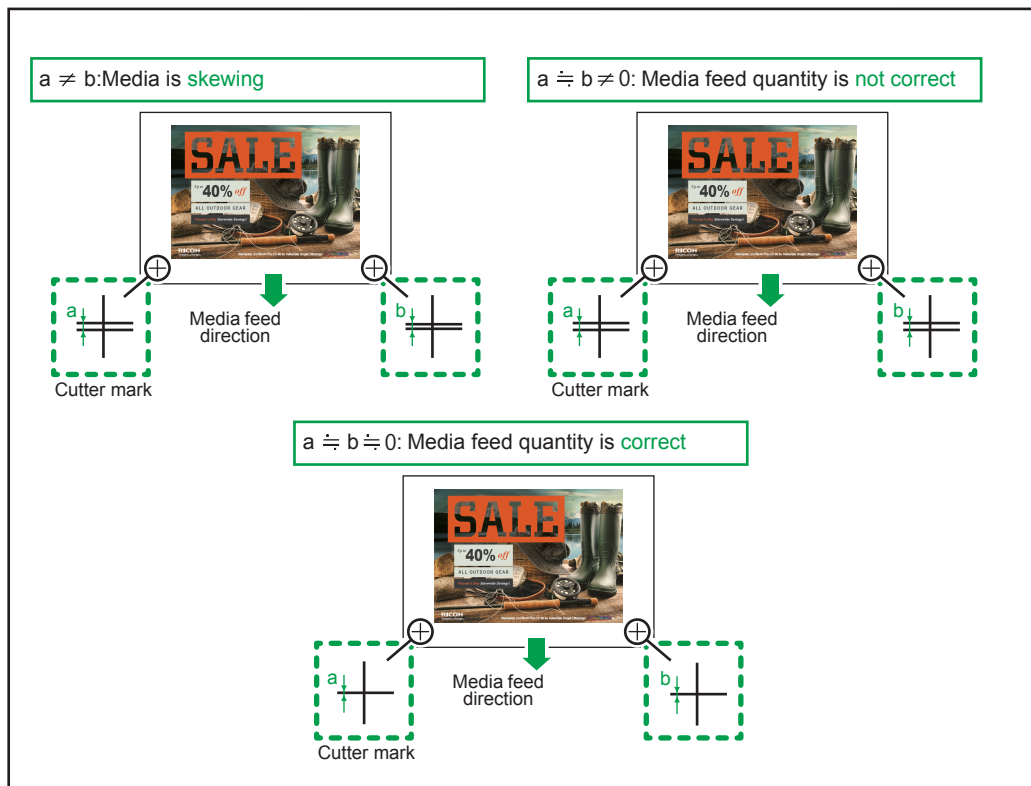

MOBXIC0004

STEP1-1 If there is skewing

1. The media has not been loaded correctly.

Load the media correctly. See the video, which describes how to load the media, or see the section "Setting Media" in the manual "Operating Instructions".

How to load the media:

<https://www.youtube.com/watch?v=aRqvMQcMTg&feature=youtu.be>



MOBXIC0017

https://2280171.mediaspace.kaltura.com/media/How+to+set+media+on+the+Pro+L5130+series+of+wide+format+devices/1_mlm093yt

2. The media may be being printed in a rewind state.

If you print on the media rewind area, the machine cannot feed the media correctly. Use only one way.

3. The media edge may have touched the floor.

If the media edge comes into contact with the floor and the media is pulled to one side, a media skew occurs. Use the roll-up unit to prevent the media edge from touching the floor.

Solutions

STEP1-2 If the media feed quantity is not correct

1. You have not adjusted feed quantity and drop position.

Perform the feed quantity adjustment when change the media, because optimal feed quantity differs for each media.

See the section "Adjusting the Media Feed Quantity" in the manual "Operating Instructions".

2. The media feed was adjusted in the part where the media has been fed and moved back or the media is deformed due to heating.

Parts of media moved back at once has damage due to the heater temperatures and registration roller.

If you adjust the media feed quantity in the damaged part, a problem such as uneven density, white lines, or black lines may occur on the media that is undamaged because the optimal feed quantity may differ between the damaged and undamaged parts.

If this happens, adjust the media feed quantity in the unreworked part.

STEP2 Adjust the actual image by Media Feed Adjustment (Micro Setting)

If STEP 1 does not solve the uneven density, try the STEP2 solutions. STEP2 has two options.

1. Adjust the image by Media Feed Adjustment (Micro Setting) and Media Feed Correction.
2. Print by upper print mode.(for example 16 pass is upper print mode of 12 pass.)

Adjusting the image takes time and consumes the media.

Total print time by upper print mode is less than in case of adjusting the actual image by Media feed adjustment (micro setting) and the media feed correction.

[Image Adjustment by Micro-Setting]

When changing "Micro Setting" to a negative value, the media feed quantity will become shorter. (Media feed quantity is the green line ① on the following figure.)

As a result, the uneven density is decreased, but black lines could appear when feed quantity is shorter than image length when printing each pass. (Image length is the gray line ② on the following figure.)

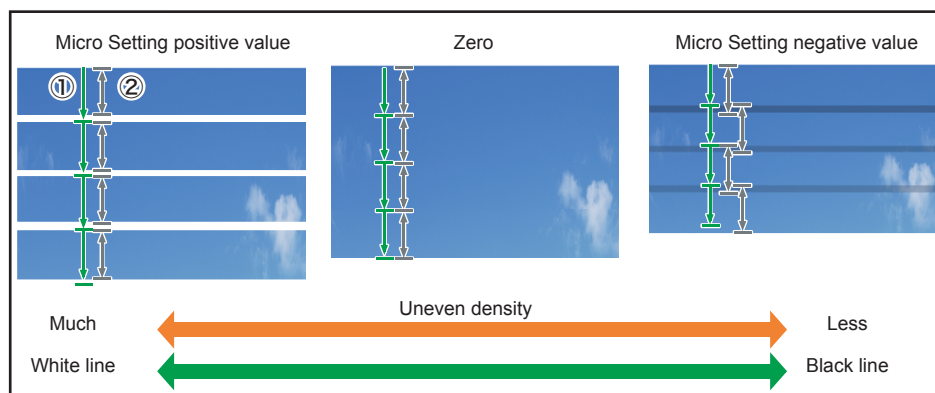

CIP Training L5160/L5130

Solutions

Refer to "Troubleshooting" in the manual "Operating Instructions" for instructions on how to adjust the media feed.

- Media Feed Correction

You can remove black lines using "Media Feed Correction".

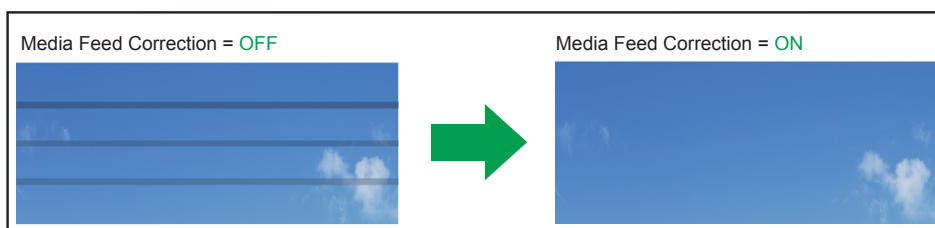

You can select the level of media feed correction from level 0 to level 3. Typically, it should be set to level 0.

If you can see any black lines, change the setting to level 1.

If this does not solve the problem, change the setting to a higher level.

★ Important

- If media feed correction is too strong, white bands may occur. Setting level 0 or level 1 is recommended.

Setting	Meaning
Off	Media Feed Correction is turned off in all print modes
Level 0	Media Feed Correction is turned off in the corresponding print mode.
Level 1	Media Feed Correction is on.
Level 2	Stronger than level 1
Level 3	Stronger than level 1 and level 2

Refer to "Troubleshooting" in the manual "Operating Instructions" for instructions on how to adjust the media feed correction.

CIP Training L5160/L5130

Solutions

Uneven density at the media edge (Not in the centre)

[Problem]

Uneven density occurs at the edge of media.



MOBXIC0020

[Cause/Technical reason]

When you use eccentric media, uneven density occurs because media feed quantity is not even at the center or edge of the media.

In many cases, since the tension at the media edge becomes loose, the feed amount is not stable and uneven density occurs.

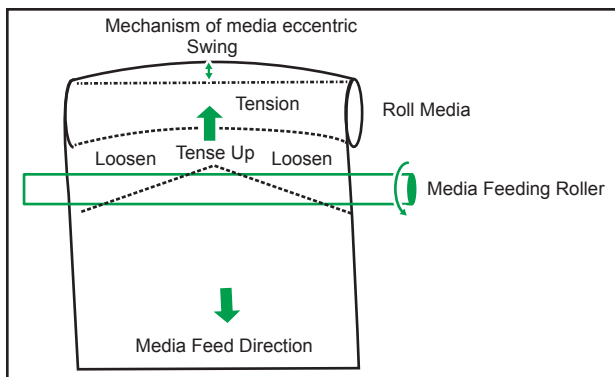

MOBXIC0021

[Solution]

If the roll media is being stored in an unsuitable way, it may become deformed. Support the roll core so that the media does not touch the floor.

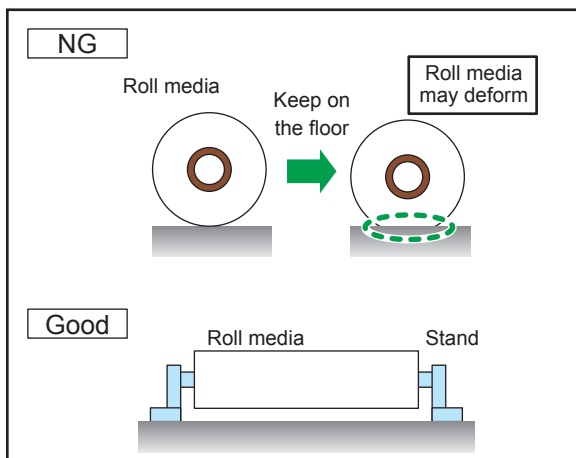

MOBXIC0022

Solutions

Uneven density (Media is stuck on the platen)

[Problem]



MOBXIC0001

[Cause/Technical reason]

The media may be stuck to the platen. If media that is sticky on the back is being used, the media may stick to the platen or roll media, resulting in a paper feed error. Also, the platen may be stained, resulting in paper feed error.

[Solution]

- Because of the heater temperature, the media may become stickier. Reduce the heater temperature.
If ink is adhesive on the platen, clean it with a paper towel soaked in alcohol such as Solmix.(Refer to the section "Cleaning the platen" in the manual "Requests for Daily Care and Maintenance".)
- If the media sticks on the roll media:
Please pull out the media once and wind it around the roll core again. The media stickiness will become weaker.

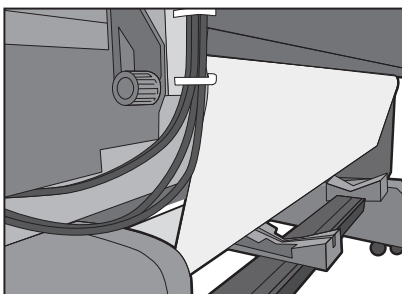

MOBXIC00
23

Good

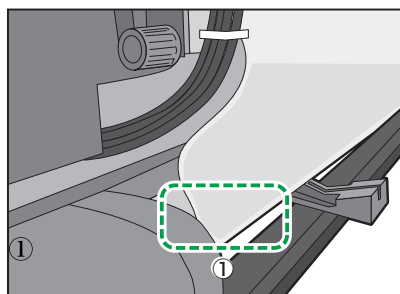

MOBXIC00
24

1. Bad - Sticking on the roll media

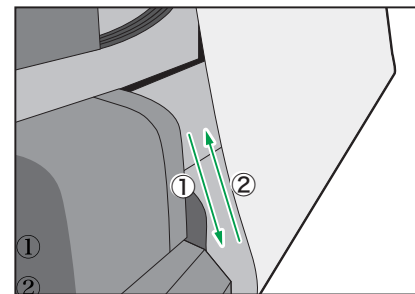

MOBXIC00
25

**1. Pull out
2. Wind again**

Solutions

Black Lines (Major case)

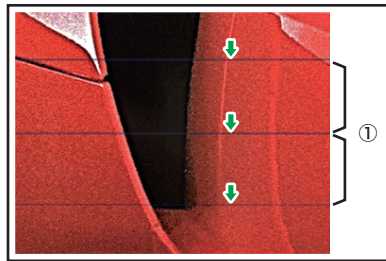
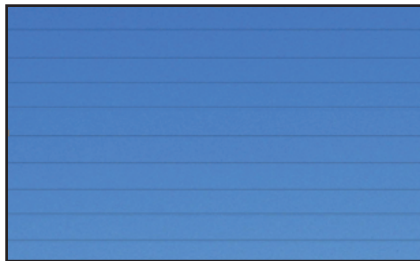

1. Media feeding pitch
[Cause/Technical reason]

1. The media feed quantity is not correct.
The feed quantity is not adjusted properly or Media Feed Adjustment (Micro Setting) is too short.
2. The heater temperature is not high enough to dry the dropped ink.
In the case of using high speed mode (6pass or 8pass), black lines occur at only dark image position due to too much ink.

[Solution]

1. Adjust the feed quantity correctly, because optimal feed quantity differs for each media. See the section "Adjusting the Media Feed Quantity" in the manual "Operating Instructions". In the case of adjusting the media feed quantity with the part where the media has been fed and moved back or the deformed due to heating, adjusted value may be incorrect.
The rewind media and heated media are damaged by the registration roller and heater temperature. If you adjust feed quantity in the damaged part, black lines may occur on undamaged parts, because the optimal feed quantity may differ between damaged parts and undamaged parts.
2. Change the heater temperature settings to higher or increase the drying time.
Change the pre and print heater settings to about 10 °C higher.
Use UNI direction to increase the drying time. It can be select on RIP software.

When using ONYX RIP, open print setting:

- select Unidirectional on printing direction.

When using ColorGATE RIP, right click on the job:

- select "Settings"
- select "Advanced"
- under the "Color" tab "Bidirectional"
- select "Settings"
- select the "Print Mode" tab and untick

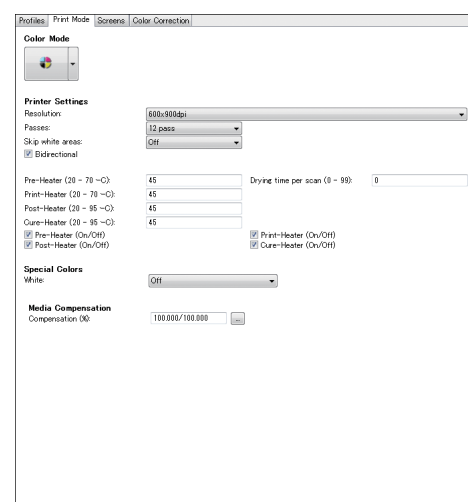

CIP Training L5160/L5130

Solutions

Black Lines (Vacuum level is not Correct)

1. The media setting is not correct.
 - Black lines occur.



[Cause/Technical reason]

A black line may occur if you raise the vacuum level after adjusting the media feed quantity. This is because the media feed quantity differs as the load of the media increases. The following images describe the trend of the vacuum level and black lines. As the vacuum level get stronger, black lines become noticeable.



* +9 is the strongest setting

* Feed adjustment is performed at vacuum setting +2

[Solution]

Basically, default setting is the best to get the high quality image.

If the media jams or floats, raise the vacuum level and perform feed adjustment after changing the vacuum level setting.

CIP Training L5160/L5130

Solutions

Black Lines (level changes as the job progresses.)

Black lines occur, and the level changes as the job progresses.

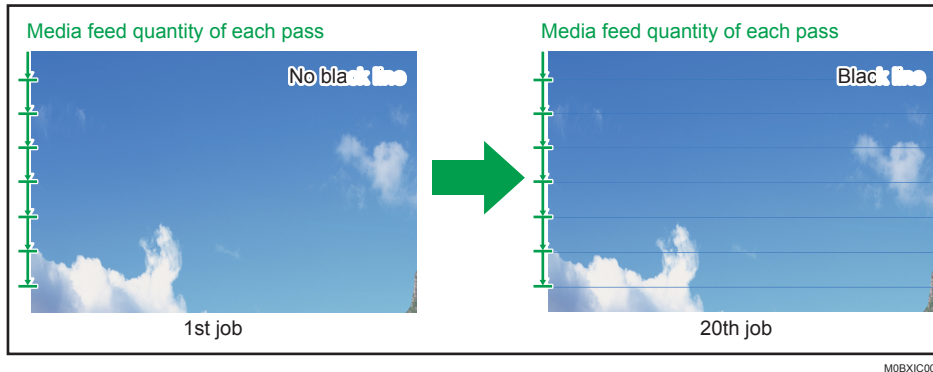

[Cause/Technical reason]

Media thickness is not correct.

Feed quantity is corrected according to the media thickness setting while printing. If this setting is not correct, the correction function does not work.

[Solution]

Please set the media settings correctly referring to the section "Setting Media" in the manual "Operating Instructions".

White Lines

White lines occur.

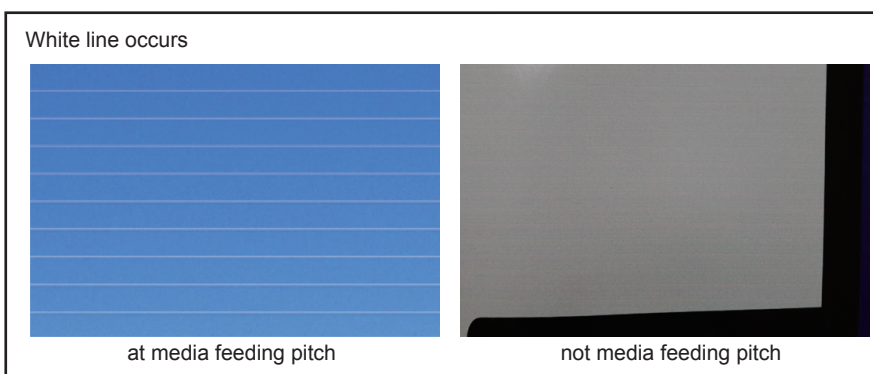

[Cause/Technical reason]

There are two reasons for the white lines.

1. Media feed quantity is not correct.
2. Nozzle is clogged, or nozzle face is dirty

CIP Training L5160/L5130

Solutions

You can recognize the reason for the white lines by analyzing the actual image in progress. See the following figure.

If the white lines occur on each media feed position, media feed quantity is not properly adjusted. If the white lines occur at another position or the white line pitch is not the same as the media feed pitch, the print heads have a problem.

White line are on each media feed position

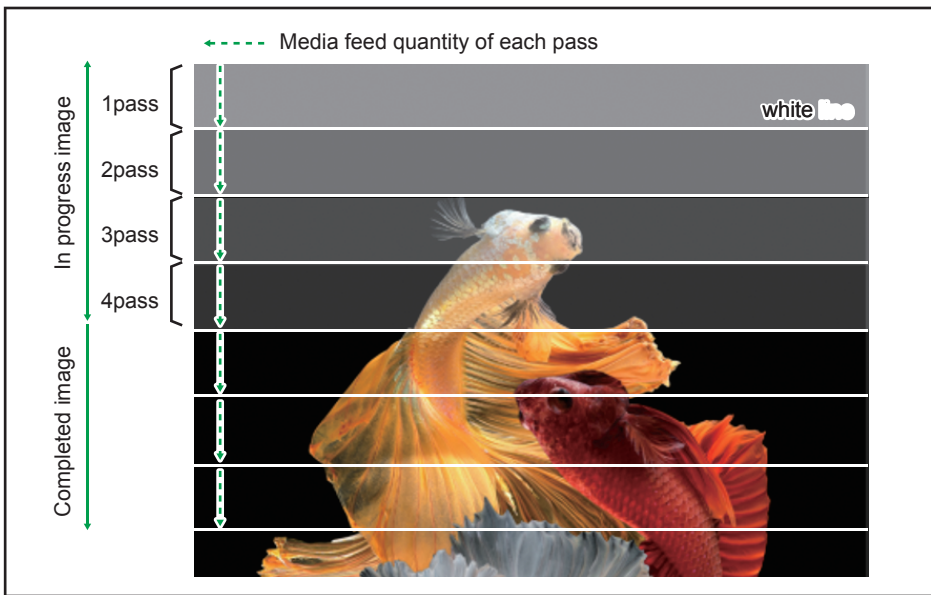

MOBXIC0031

White line are inside each media feed position

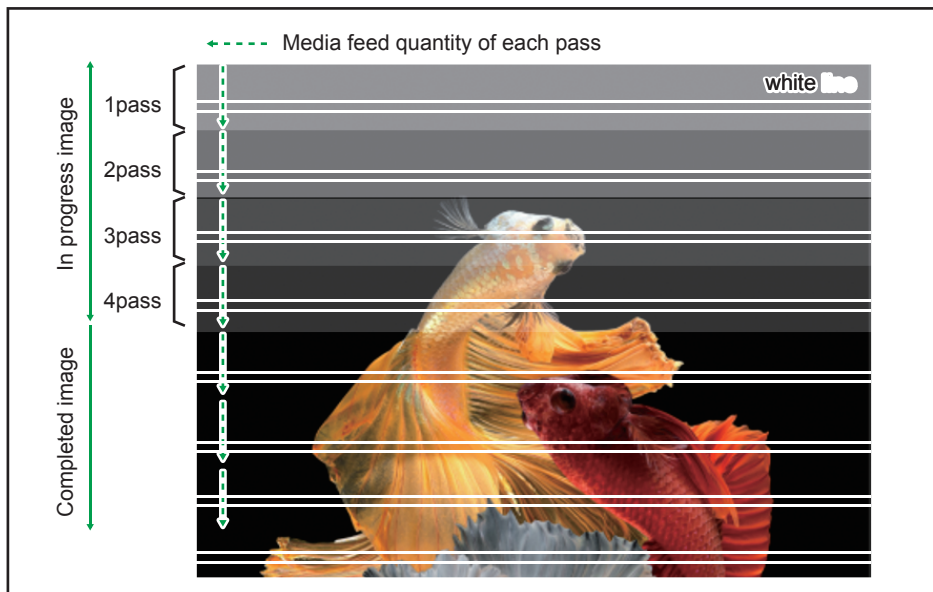

MOBXIC0032

CIP Training L5160/L5130

Solutions

[Solution]

1. Adjust the media feed quantity.

Adjust the feed quantity correctly, because optimal feed quantity differs for each media. See the section "Adjusting the Media Feed Quantity" in the manual "Operating Instructions".

The rewound media and heated media are damaged by the registration roller and heater temperature. If you adjust feed quantity in the damaged part, black lines may occur on undamaged parts, because the optimal feed quantity may differ between damaged parts and undamaged parts.

See the section "Uneven density or black streaks occur on the printed image" in the manual "Operating Instructions".

2. Clean print heads.

See the section "Cleaning Print Head Nozzles" in the manual "Operating Instructions".

When ink is deposited on the media guides or cap, the print heads will become dirty quickly even if the print heads are cleaned.

Also, see the relevant section in "Requests for Daily Care and Maintenance".

Characters Are Unclear/Faint/Blurred (Case 1)

The printed image is faint in the horizontal direction.

[Cause/Technical reason]

Drop position adjustment has not been performed.

[Solution]

Carry out drop position adjustment.

For details about adjustment, see section "Adjusting the Drop Position" in the manual "Operating Instructions".

Characters Are Unclear/Faint/Blurred (Case 2)

The printed image is faint in the vertical direction.

[Cause/Technical reason]

Media feed quantity adjustment has not been performed.

[Solution]

Adjust media feed quantity.

For details about adjustment, see the section "Adjusting the Media Feed Quantity" in the manual "Operating Instructions".

In the case of adjusting the media feed quantity with the part where the media has been fed and moved back or the deformed due to heating, adjusted value may be incorrect.

The rewound media and heated media are damaged by the registration roller and heater temperature. If you adjust feed quantity in the damaged part, black lines may occur on undamaged parts, because the optimal feed quantity may differ between damaged parts and undamaged parts.

Solutions

Characters Are Unclear/Faint/Blurred (Case 3)

Characters are faint (lines are duplicated) in the image on the left and right sides (does not occur at the center.)

Original Data

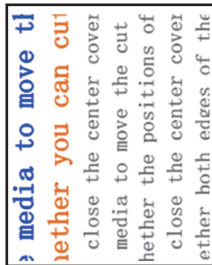

MOBXIC1072

When printing the same image

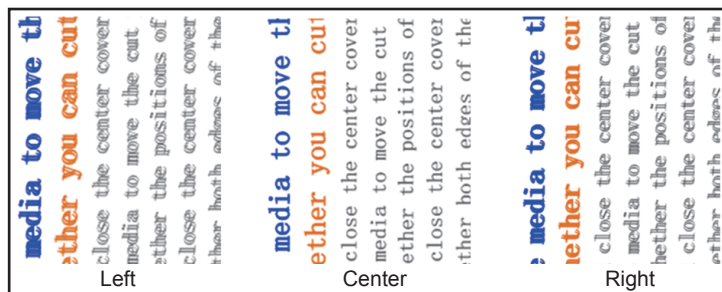

MOBXIC0033

[Cause/Technical reason]

If media skew occurs, the image written by print head 1 and print head 3 will not be overlapped. (See the following figure)

If the media is skewed, it may be fed in the direction of rotation.

In that case, misalignment occurs in the vertical direction.

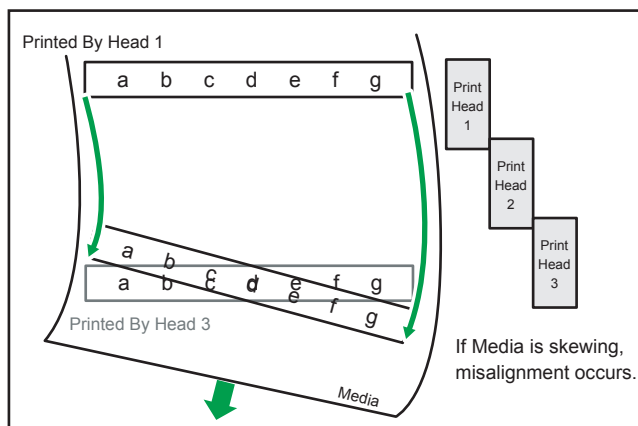

MOBXIC0034

[Solution]

Load the media correctly.

See the video which describes how to load the media or the section "Setting Media" in the manual "Operating Instructions".

How to load the media:

<https://www.youtube.com/watch?v=aRqvMQCfMTg&feature=youtu.be>

Solutions



MOBXIC0017

https://2280171.mediaspace.kaltura.com/media/How+to+set+media+on+the+Pro+L5130+series+of+wide+format+devices/1_mlm093yt

Characters Are Unclear/Faint/Blurred (Case 4)

[Problem]

Image misalignment occurs even if drop position adjustment and feed quantity adjustment are successful.

[Cause/Technical reason]

There are two reasons that may cause this problem.

1. The temperature used for the pre-heater or print heater is high enough to deform the media, making it wavy or curled.
2. Using uneven media such as those with nubby texture, holes, and patterns.

If you perform auto drop position adjustment in a deformed part or on uneven media, this function does not work properly. Image misalignment occurs due to incorrect adjustment values.

[Solution]

Please adjust the drop position in an un-deformed part of the media. There are two solutions for preventing deformation of the media.

1. Changing the pre-heater and print heater to a lower setting.
When it is too low, bleeding may appear. Therefore, you should change the setting little by little and see how the media behaves at each temperature.
See page 30 "Heater temperature & ink limit".
2. Changing vacuum level to a stronger setting.
Please adjust the feed quantity after changing the vacuum level.
When the vacuum level is too strong, black lines may appear.

If you use the uneven media, perform the manual drop position adjustment.

See the section "Adjusting the Media Feed Quantity" in Operating Instructions.

We recommend using adjustment value register and retrieve function.

It is possible to omit the adjustment of media feed quantity when using the same media again.

CIP Training L5160/L5130

Solutions

The colors are different from the original image in the gradation part.

The gradation is unsmooth, or the color is different.

Original image

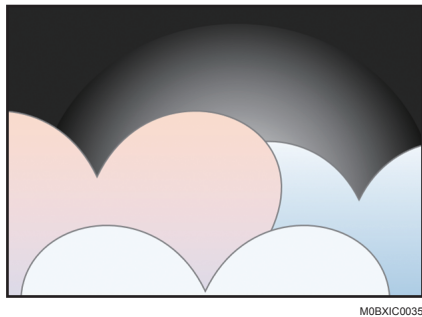

MOBXIC0035

Abnormal image

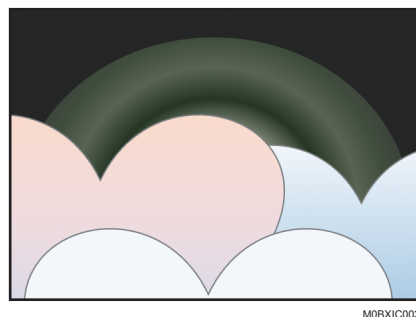

MOBXIC0036

[Cause/Technical reason]

If you are not using a profile specific to the media, the ICC profile does not match, and gradation is not produced correctly.

[Solution]

Select the proper media profile matched with the media.

If you do not have the dedicated media profile, look for the media profile in Profile library or make a media profile.

[Profile library]

 **Region A** (mainly Europe and Asia)

ColorBase - <https://ricoh.color-base.com/>

 **Region B** (mainly North America)

Business Booster - <https://ricohbusinessbooster.com/production-portfolio/color-profile/>

CIP Training L5160/L5130

Solutions

Unexpected ink adhesion on the printed image or media guide.

[Problem]

- The media guides are dirty.
- White lines or black dots occur on the printed image.

[Cause/Technical reason]

Ink is deposited on the nozzle faces of the print head and the cap each time the machine is used.(Top image)

The deposited ink on the cap edge causes the print head to become dirty, and deposited ink on the print heads makes the image or media guide dirty. (Bottom image)

Deposited ink on cap and print head

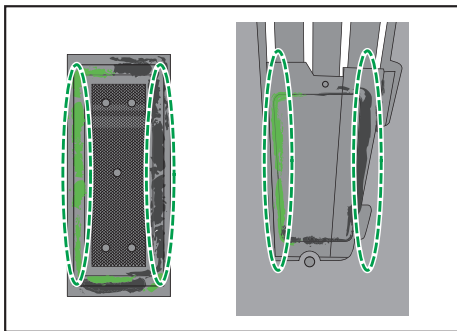

MOBXIC0037

Media guide and image

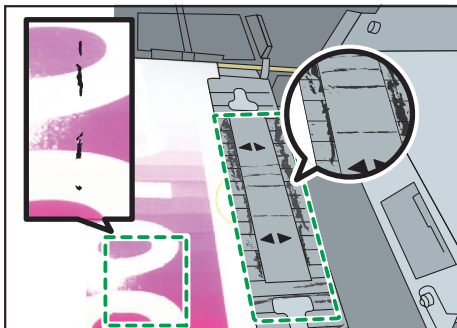

MOBXIC0038

[Solution]

Please periodically clean print heads, media guides, and head caps.

Solutions

If you do not know how to specify the print settings

Head height

We recommend the default settings for the best image quality.

Increase the setting only if a media jam occurs or the print head rubs the media.

Adjust the drop position again after changing the setting to prevent the abnormal image.

Setting	Head Height (mm)	Head Height (inches)
default	1.8±0.2mm	0.07 inches
+1	2.3±0.2mm	0.09 inches
+2	2.8±0.2mm	0.11 inches
+3	3.8±0.2mm	0.15 inches

Media thickness

Check the media thickness information on the media data sheet or website, and set the appropriate setting values in the table below.

Setting	Media thickness (mm)	Media Thickness (inches)
-2	0.05 - 0.1 mm	0.002-0.004 inches
-1	0.1 - 15 mm	0.004-0.006 inches
0	0.15 - 0.2 mm	0.006-0.008 inches
+1	0.2 - 0.3 mm	0.008-0.012 inches
+2	0.3 - 0.5 mm	0.012 - 0.02 inches

If you do not know the media thickness information, try using the following reference settings.

CIP Training L5160/L5130

Solutions

[Reference settings]

Media Type	Media Thickness	Width (mm)	Thickness (mm)	Setting
PVC	LINTEC GIY-11Z5	1370	0.286	+1
	Avery Dennison EU MPI 3000 Gloss	1370	0.23	+1
PET	Kimoto TP-188	1600/1300	0.189	0
Soft signage	SEIREN SS8000	1370/914/610	0.19	0
Synthetic paper	Yupo VJFP120	1270	0.11	-1
Coated paper	Sihl 3257	1524/1370	0.192	0
Paper	NAKAGAWA MFG. CO IJ plain paper	841/594	0.098	-2
Wallpaper	LINTEC PROW-AP400F	930	0.249	+1
Canvas	Sihl 3609	1370	0.421	+2
Tarpaulin	Ultraflex 13oz jetflex Gloss	1370	0.352	+2

Vacuum level

The default setting is the best setting for high quality.

When the media is wavy, raise the vacuum level.

If the vacuum level is too high, the media gets lifted from the platen after feeding the media. If you see this happen, lower the vacuum level.

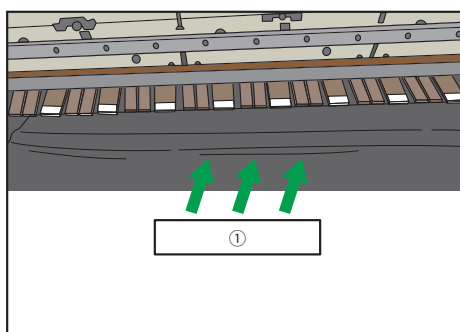

MOBXIC0039

CIP Training L5160/L5130

Solutions

1. media lifted from the platen

Adjust the media feed quantity again after changing the vacuum level to prevent the black lines.

The following images describe the trend of the vacuum level and black lines.

As the vacuum level get stronger, black lines become noticeable.

Note

- The following images describe the trend of the vacuum level and black lines.
- As the vacuum level gets stronger, black lines become noticeable. (Feed adjustment is performed at vacuum setting +2.)

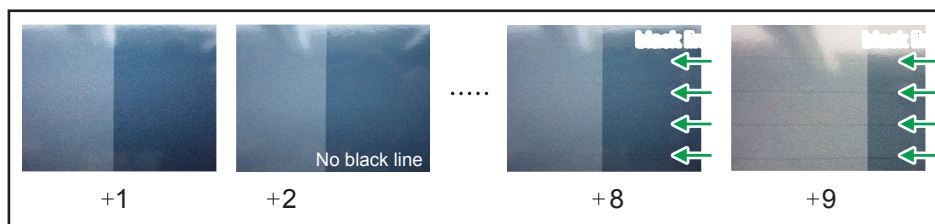

MOBXIC0028

Heater temperature & ink limit

If you do not have a media profile, adjust the heater temperature and ink limit by the following procedure.

1. Tentatively set the heater temperature to the highest value.
2. Pre and Print heater temperature settings
For details see "Heater Setting".
If the media is wavy, lower the pre and print heater temperature at intervals of 5 °C until waviness stops occurring.
3. If beading or bleeding occur on the printed image, lower the ink limit setting on RIP software. For details see "[Adjusting ink limit]".

Wavy

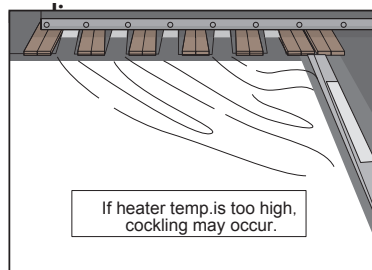

MOBXIC0040

- Media cockling

Beading



MOBXIC0041

Bleeding



MOBXIC0042

CIP Training L5160/L5130

Solutions

1. Post and Cure heater temperature setting

If the printed media becomes deformed, lower the post heater temperature at intervals of 5 °C and the cure heater at intervals of 10 °C until the media deformation stops occurring.

If blocking occurs on printed images, change the ink limit setting on RIP software.

[Adjusting ink limit]

Using ONYX RIP, Right click on the job

- Open the "Job in Job Editor"
- select the "Color Correction" tab
- select the "Primary Color Curves"
- select the "Line" on the "Edit Type" tab
- check the CMYK
- on the "Edit Channels"
- drag the graph down to the required level.

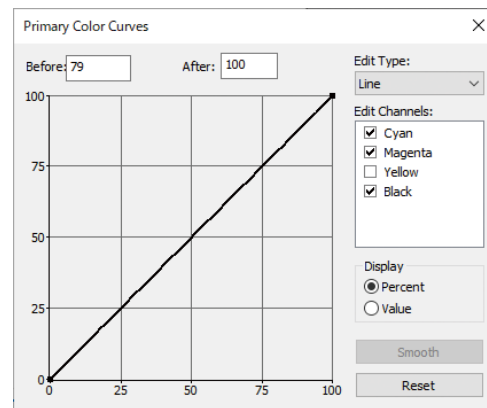

Using ColorGATE RIP, right click on the job

- select "Settings"
- select "Advanced" under the "Color" tab
- Select "Settings"
- select the "Color Correction" tab
- drag the graph down to the required level

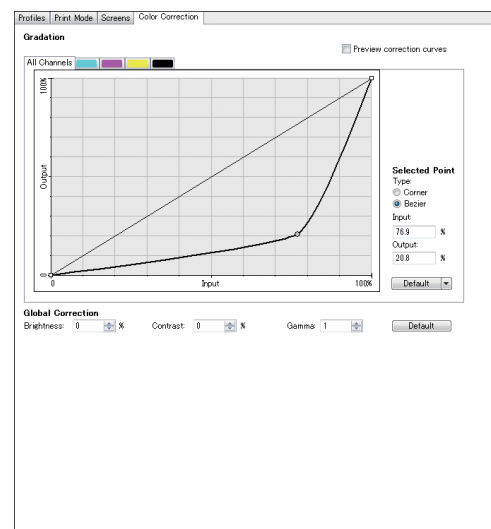

CIP Training L5160/L5130

Solutions

Heater Setting

Media Type	Pass Mode	Target Heater Setting (°C)				Remark
		PRE	PRINT	POST	CURE	
PVC	6pass	50-60	50-60	65 or 90	85 or 90	
	8pass	45-55	45-55	65 or 90	85 or 90	
	12pass	45-55	45-55	65 or 90	85 or 90	
	16pass	45-55	45-55	65 or 90	65 or 70	
	32pass	40-50	40-50	65 or 90	65 or 70	
	12 Pass (W)	-	-	-	-	Not recommended
PET	6pass	-	-	-	-	Not recommended
	8pass	-	-	-	-	Not recommended
	12pass	55-65	55-65	65 or 90	65 or 70	-
	16pass	55-65	55-65	65 or 90	65 or 70	-
	32pass	55-65	55-65	65 or 90	65 or 70	-
	12 Pass (W)	55-65	55-65	65 or 90	65 or 70	-
Coated Paper	6pass	30-40	30-40	30-35	OFF	Cure heater off recommended
	8pass	30-40	30-40	30-35	OFF	
	12pass	30-40	30-40	30-35	OFF	
	16pass	30-40	30-40	30-35	OFF	
	32pass	30-40	30-40	30-35	OFF	
	12 Pass (W)	-	-	-	-	Not recommended

CIP Training L5160/L5130

Solutions

Media Type	Pass Mode	Target Heater Setting (°C)				Remark
		PRE	PRINT	POST	CURE	
PP	6pass	40-50	40-50	50-55	50-55	
	8pass	40-50	40-50	50-55	50-55	
	12pass	40-50	40-50	50-55	50-55	
	16pass	40-50	40-50	50-55	50-55	
	32pass	35-45	35-45	50-55	50-55	
	12 Pass (W)	-	-	-	-	Not recommended
Banner	6pass	45-55	45-55	65 or 90	65 or 70	
	8pass	45-55	45-55	65 or 90	65 or 70	
	12pass	45-55	45-55	65 or 90	65 or 70	
	16pass	45-55	45-55	65 or 90	65 or 70	
	32pass	45-55	45-55	65 or 90	65 or 70	
	12 Pass (W)	-	-	-	-	Not recommended
Textile/ Fabric	6pass	35-45	35-45	50-55	50-55	
	8pass	35-45	35-45	50-55	50-55	
	12pass	35-45	35-45	50-55	50-55	
	16pass	35-45	35-45	50-55	50-55	
	32pass	35-45	35-45	50-55	50-55	
	12 Pass (W)	-	-	-	-	Not recommended
Plain Paper	6pass	OFF	OFF	OFF	OFF	All heaters off recommended
	8pass	OFF	OFF	OFF	OFF	
	12pass	OFF	OFF	OFF	OFF	
	16pass	OFF	OFF	OFF	OFF	
	32pass	OFF	OFF	OFF	OFF	
	12 Pass (W)	-	-	-	-	Not recommended

CIP Training L5160/L5130

Solutions

Media Type	Pass Mode	Target Heater Setting (°C)				Remark
		PRE	PRINT	POST	CURE	
Wallpaper	6pass	30	30	20	40	
	8pass	30	30	20	40	
	12pass	30	30	20	40	
	16pass	30	30	20	40	
	32pass	30	30	20	40	
	12 Pass (W)	-	-	-	-	Not recommended
Canvas	6pass	40-50	40-50	50-55	50-55	
	8pass	40-50	40-50	50-55	50-55	
	12pass	40-50	40-50	50-55	50-55	
	16pass	40-50	40-50	50-55	50-55	
	32pass	40-50	40-50	50-55	50-55	
	12 Pass (W)	-	-	-	-	Not recommended

Solutions

Unexpected Behavior

Auto drop position/Auto media feed quantity adjustment failed

[Problem]

Auto drop position or media feed quantity adjustment failed.

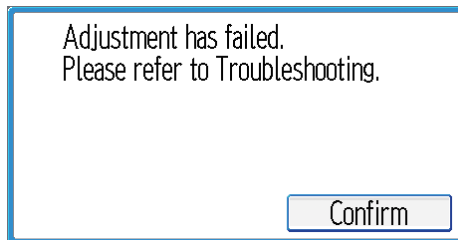

[Cause/Technical reason]

There are three possible reasons:

1. The machine could not print the adjustment pattern properly due to nozzles clogging.
2. Using unsupported media.
3. Adjustment patterns are out of sensing area because misalignment is too big.

[Solution]

1. If the pattern is not clear, execute the nozzle cleaning.

See the section "Cleaning Print Head Nozzles" in the manual "Operating Instructions".

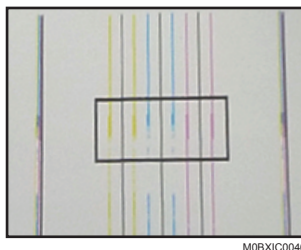

2. If you are using the following media, adjust the drop position and media feed quantity manually.

- Transparent media.
- Colored media.
- Texture or fabric media
- Holed media.
- Patterned media.
- High reflective media
- Uneven Media

3. Adjust the drop position and media feed quantity manually.

See the sections "Adjusting the Drop Position" and "Adjusting the Media Feed Quantity" in "Operation instructions".

CIP Training L5160/L5130

Solutions

Nozzle clogging

[Problem]

There are many nozzles clogged after leaving the machine idle. (Nozzle clogging for more than 10ch has occurred.)

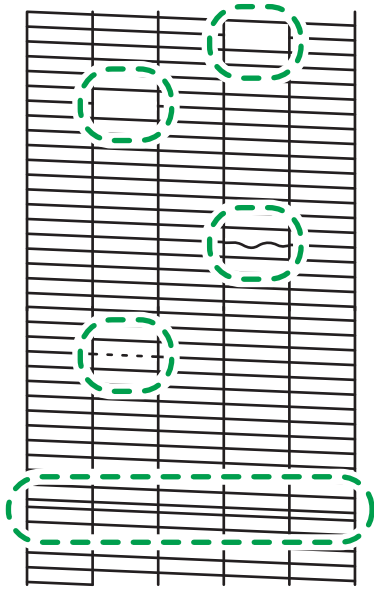

DVB195

[Cause/Technical reason]

If the humidity in the location of the machine is under 40%, the frequency of nozzles clogging may increase.

(For details about the operating environments, see "Getting Started" in the Operating Instructions.)

[Solution]

Please change the auto maintenance setting if using the machine under recommended humidity levels.

We recommend increasing auto maintenance frequency little by little while watching.

Ink consumption will increase when the maintenance frequency is increased.

(Refer to the section "Using the Auto Maintenance Function" in the manual "Operating Instructions".)

First, change the "Flushing Interval" setting to Level 2 or Level 3. (Default is Level 1)

The frequency for discharging ink that accumulates in the print heads increases.

If it is not enough, change the "Cleaning Interval" setting to Level 2 or Level 3. (Default is Level 1)

The frequency for cleaning print head nozzles increases.

When using a 4CW machine, you can set cleaning intervals for white heads independently.

CIP Training L5160/L5130

Solutions

Flushing Interval

Set the frequency for discharging ink that accumulates in the print heads.

- Level 1 (Lo): every 30 minutes
- Level 2: every 20 minutes
- Level 3 (Hi): every 10 minutes

Default: **[Level 1 (Lo)] Cleaning Interval**

Set the frequency for cleaning print head nozzles.

- Level 1 (Lo): every 12 hours
- Level 2: every 6 hours
- Level 3 (Hi): every 3 hours

Default: **[Level 1 (Lo)] Cleaning (White) Interval**

Set the cleaning frequency to prevent white ink from clogging.

- Level 1 (Lo): every 4 hours
- Level 2: every 2 hours
- Level 3 (Hi): every hours

Default: **[Level 1 (Lo)] Ink Circulation Interval**

Set the circulation frequency to avoid white ink from settling in the ink supply route.

- Level 1 (Lo): every 3 hours
- Level 2: every 2 hours
- Level 3 (Hi): every hours

Default: **[Level 3 (Hi)]**

Solutions

Width detection fails

[Problem]

Width detection fails.

[Cause/Technical reason]

Media width is detected by a photo reflective sensor at above the black line.

If you use a media that does not reflect the light, the media width may not be detected.

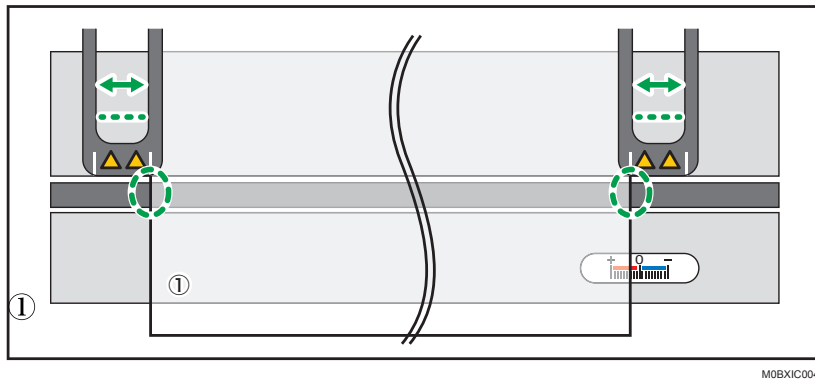

1. Media

[Solution]

Stick tape on the black line so that the machine can detect the media edge.

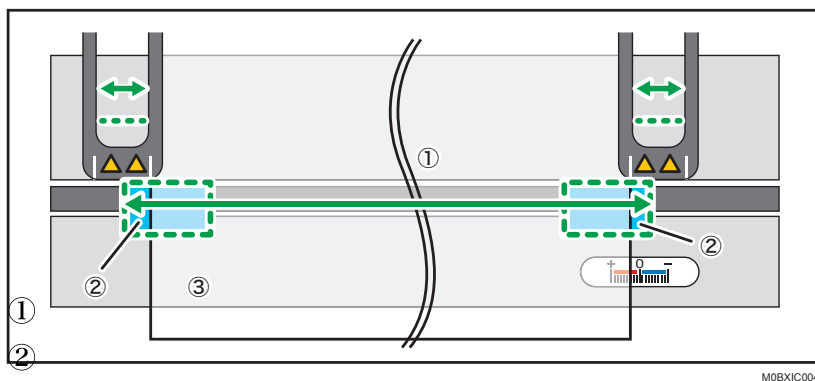

1. Media width
2. Tape
3. Media

★ Important

- If the image size is bigger than the media width that is detected, the machine may print on media guides or platen. Print with large enough margins.

Solutions

Media end is detected incorrectly (case 1)

[Problem]

"Media end" is detected even though media is still on the roll.

[Cause/Technical reason]

The roll holder is idling because the roll core size does not fit correctly.

Media remaining quantity is estimated from the rotation amount of roll media. If the flange is idling, the rotation amount is not measured correctly, and the remaining quantity is detected as smaller.

[Solution]

- Please set the roll core to the roll holder securely.

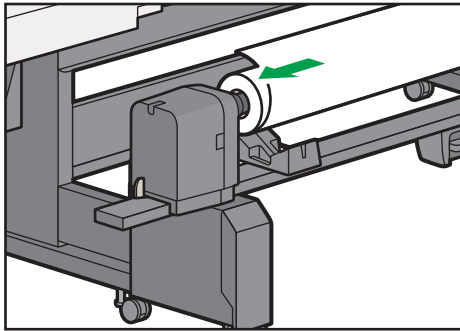

DWT126

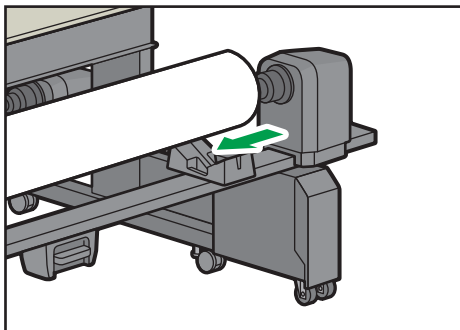

DWT128

- If roll core size is too large, put the tape on the inside of the roll core, like the following figure.

Roll Core

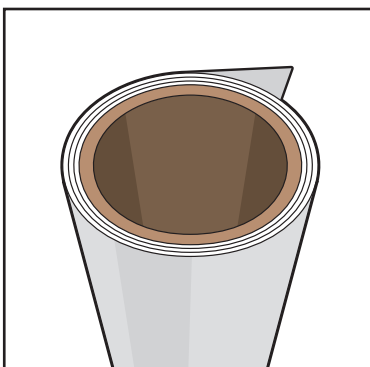

M0BXIC0052

Roll Core with Tape

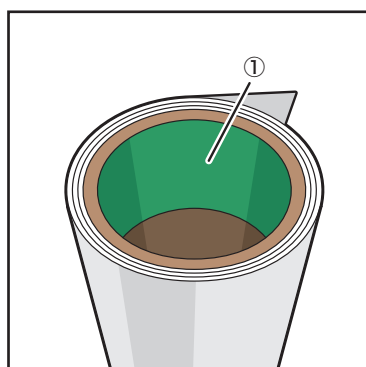

M0BXIC0053

1. Stick the tape on the inside of roll core

Solutions

Media end is detected incorrectly (case 2)

[Problem]

"Media end" is detected even though there is remaining media.

[Cause/Technical reason]

Media is stuck on the platen.

Reasons why the media is stuck on the platen:

1. Media is sticky, and stickiness is increased by heater temperature.
2. Static electricity is high because the humidity of the operating location is too low.
3. Friction is raising because platen is dirty.

[Solution]

1. Lower the heater temperature.

When it is too low, bleeding and blocking may appear. Therefore, you should change setting little by little while watching.

2. If the humidity in the location of the machine is under 40%, please adjust the humidity with a humidifier.
(Operating environments are described in the section "Getting Started" the manual "Operating Instructions".)
3. If ink is sticking on the platen, clean it with a paper towel soaked in alcohol such as Solmix.(Refer to the section "Cleaning the platen" in "Requests for Daily Care and Maintenance".)

Solutions

Convenient Usage

Reducing Print Preparation Time and Media Consumption

Print settings Registration/Retrieval function overview

Using print settings Retrieval / Retrieved function, it is possible to shorten the adjustment time because the drop position and feed quantity adjustment can be omitted when you use the same media again. In this function, print settings can be registered / retrieved as one parameter set.

Print settings are indicated below:

- Media settings: media type, head height, media thickness, vacuum level, leaf or roll
- Adjustment values: drop position adjustment value and feed quantity adjustment value.

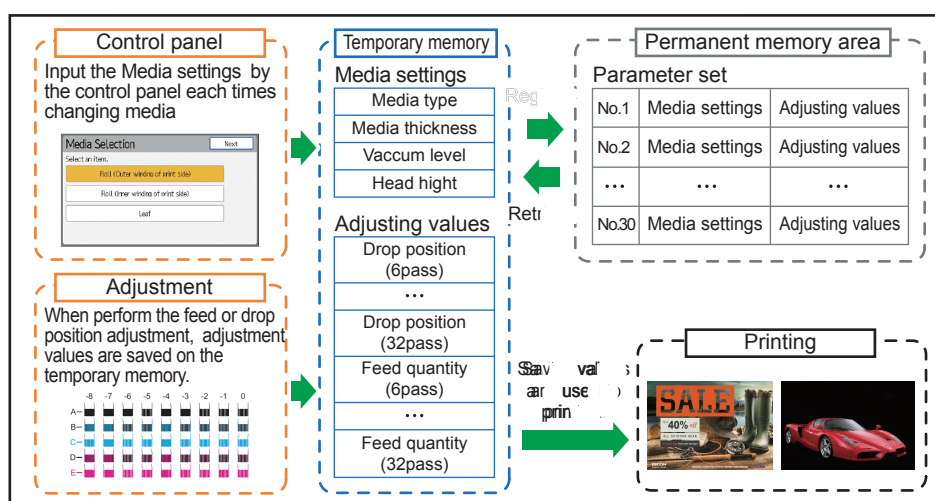

MOBXIC0054

Registering/retrieving print settings

This section describes how to register and retrieve print settings.

You can achieve a stable print quality by registering/retrieving print settings for each product number of the media you are using.

By doing this, you can skip drop position and feed quantity adjustment, shortening the adjustment time and reducing waste media, when you use the same media again.

★ Important

- Abnormal images may occur depending on the production lots of the media and the environment.
- If it occurs, perform the feed quantity adjustment and drop position adjustment again.

CIP Training L5160/L5130

Solutions

- When retrieving print settings, you cannot check the registered settings. Note the registered settings on the print setting storage sheet. For details see "Print settings registered sheet".

Print settings registered sheet Attention: Strongly recommend adjusting the "Media Feed Quantity" by each job or roll.

No.	Registration date	Media information		Media and machine settings					Adjusted print mode					Remarks		
		Media type	Manufacturer Model number	Roll Outer/ Roll Inner/Leaf	Take-up reel Use/Not use	Media thickness	Head height	Vacuum level	Media width	6pass	8pass	12pass	16pass		32pass	12pass (W)
(Ex)	DDMM/YYYY HHMM	PVC	AAA-XXX-YYZZ	Roll Outer	Use	1	Default	2	1300mm	✓		✓				
1																
2																
3																
4																
5																

MOBXIC0055

Registration

- Fill in the registration time, media type, model number, roll/leaf, outer/inner winding, head height, vacuum level, media width, and media thickness on the print setting storage sheet.

The confirmation method is indicating below.

setting	How to check
Media type Product number	Check the website of the media vendor or the media package.
Roll/leaf setting	(Fill in the setting selected at media set.)
Outer/Inner winding of print side	(Fill in the setting selected at media set.)
Head height	Press [Standard Procedure] key on the home screen ► Head height
Vacuum level	Press [Standard Procedure] key on the home screen ► Press [Media Settings] ► Vacuum Level
Media width Media thickness	Press [Check Status] key on the home screen ► Media tab

- Perform the media feed quantity and drop position adjustment.

Select the adjustment mode from [6 Pass], [8 Pass], [12 Pass], [16 Pass], and [32 Pass].

in the case of 4CW machines, select from [6 Pass], [8 Pass], [12 Pass], [16 Pass], [32 Pass], and [12 Pass (W)].

CIP Training L5160/L5130

Solutions

3. Press the [Standard procedure] key.

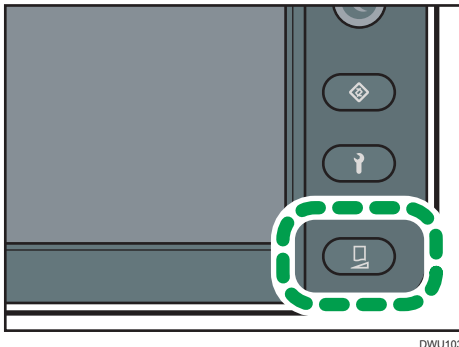

4. Press [▼].

5. Press [Media Records Register / Retrieve].

6. Press [Media Records Register].

7. Press [▲] or [▼] to select the number you want to register.

- Selectable numbers are from 01 to 30.

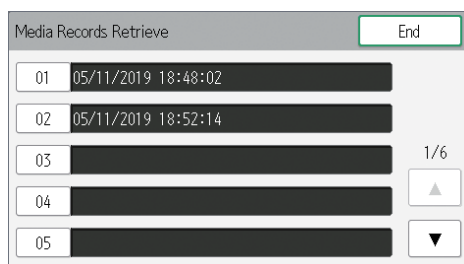

8. Press Enter.

9. Fill in the registered number on the print setting storage sheet.

10. Select the mode you adjusted in advance to register from [6 Pass], [8 Pass], [12 Pass], [16 Pass], and [32 Pass].

in the case of 4CW machines, select from [6 Pass], [8 Pass], [12 Pass], [16 Pass], [32 Pass], and [12 Pass (W)].

- It is possible to select Multiple print modes.
- When registering all adjustment values, press [Register All Modes].

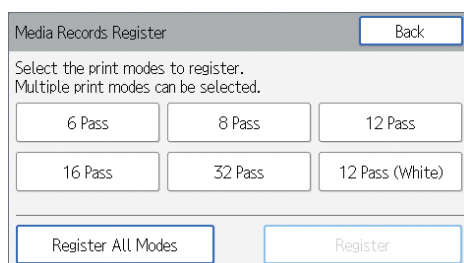

CIP Training L5160/L5130

Solutions

11. Press [Register].

This step is omitted when [Register All Modes] is selected.

12. Press [Execute].

- Adjustment values of selected mode are registered.
- Date and time are displayed in the order of day/month/year time: minute: second.
- The registration date and time are updated when registered values are overwritten or another adjustment value is added.

13. Fill in the mode that you registered on the print setting storage sheet.

14. Press [Confirm].

15. Press [End].

Retrieving registered settings

This section describes how to retrieve the registered Print settings when changing or reloading the media.

1. Set the media.
2. Lower the media lock lever.

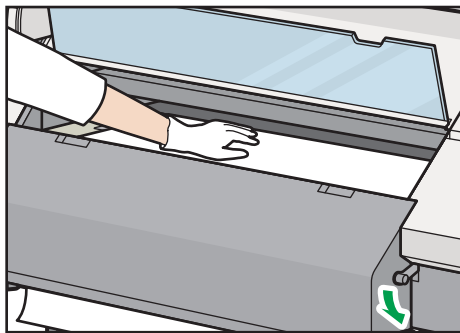

3. Press [Yes].

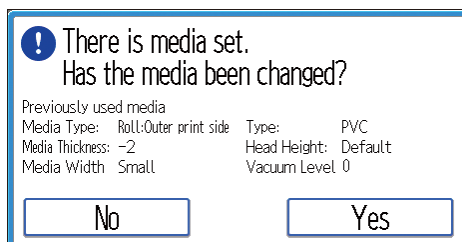

4. Press [Yes].

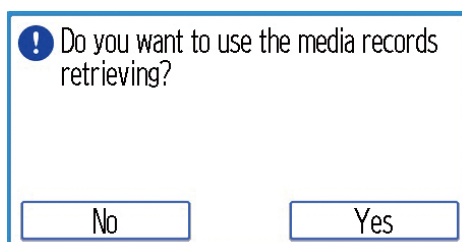

CIP Training L5160/L5130

Solutions

5. Check the print setting storage sheet for the numbers where the print settings used for printing are stored.
6. Press [▲] or [▼] to select the number for which the adjustment value to be recalled is registered.
 - The number displayed as [Unregistered] can not be selected.

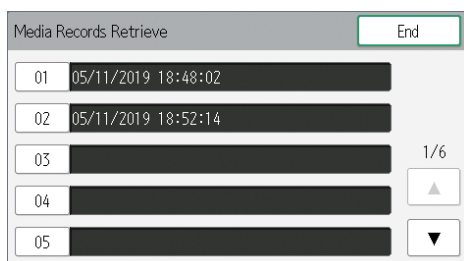

7. Press [Execute].

The print settings registered in advance is retrieved.
8. Press [Confirm].

Note

- If there is no registered print setting, step 4 and later will not be displayed.
- When adding or overwriting the adjustment value, call up the print setting and perform the feed adjustment or drop position adjustment. When registering, select only the mode adjusted in advance.
- If "Cannot detect the media." is displayed, registration and retrieving cannot be performed. Load the media before performing this procedure.

Roll to Cut function

It can be used as Roll to Cut mode by changing the RIP settings.

Media is wasted at each cut approximately 770 mm (30.3 inches), when default setting.

In order to prevent the abnormal image by the media deformation, the default setting is not to rewind the media.

However, if you want to reduce the lost media, turn on the "Auto Rewind after Auto Cut". It can reduce up to 600 mm (23.6 inches) of waste media for each cut.

* Available with FW V1.07 or higher. If you cannot find this function, please contact your service representative.

Caution

Depending on the media, the image quality may be significantly degraded due to the deformation of the media due to heat, so please test with the media in advance.

Solutions

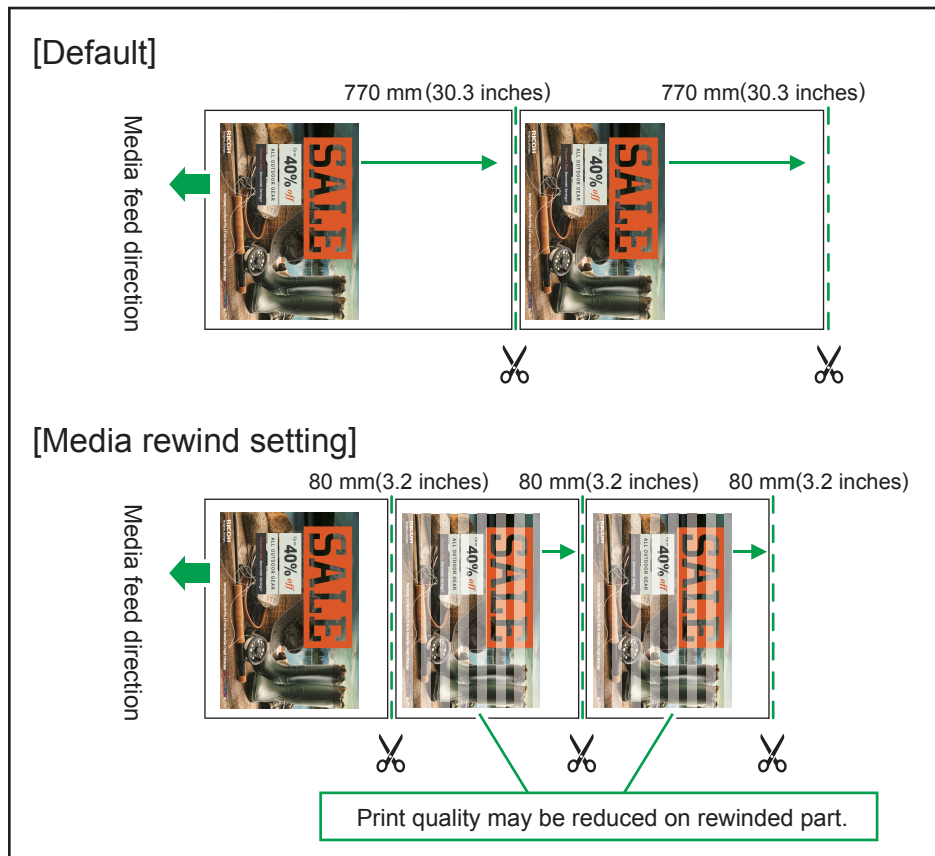

MOBXIC0065

* The above dimensions are approximate and cannot be guaranteed

★ Important

- If the printed part is contacting the floor, cutting may not work because cutter and cutter arm cannot catch the media. In addition, media may be skewed, and image quality may be degraded.

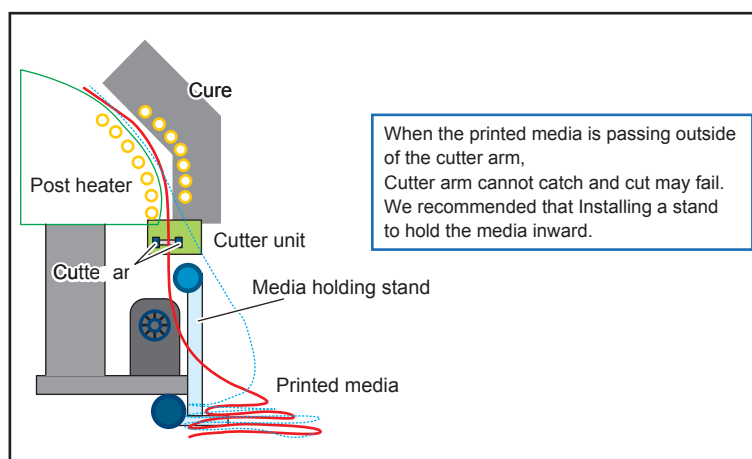

MOBXIC0066

CIP Training L5160/L5130

Solutions

How to set auto cut function

- To Set the auto cut function on the ONYX RIP:
Right click on the job ► Open the "Edit" ► select the "Printer Settings" tab ► click the "Auto Paper Cut" check box.
- To set auto cut function on the ColorGATE RIP:
Right click the job ► select "Settings" ► select the "Printer" tab ► click the "Cutter" check box.

How to set Auto Rewind function after Auto cut

[Print Adjustment] key ► [Media Settings] ► [Auto Rewind after Auto Cut]

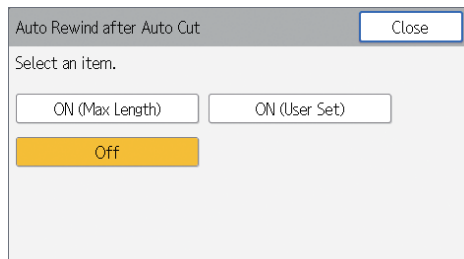
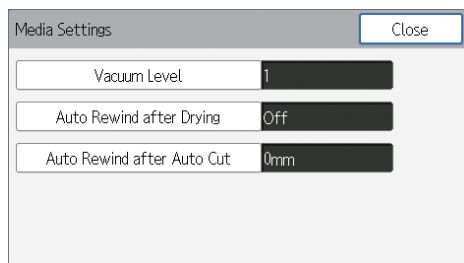

ON (Max Length): Rewind the media 600 mm (23.6 inches) automatically after auto cutting the current job

ON (User Set)*: Rewind the media 0-600 mm (0-23.6 inches) automatically after auto cutting the current job

Off: Do nothing after auto cutting the current job (Default)

* If the leading edge of cut media is curled, it may strike with the joint between platen and post heater or the space between post heater and cure heater and cause a jam. Therefore, user can adjust rewind distance after auto cutting.

CIP Training L5160/L5130

Solutions

Reducing media consumption that occurs when loading the media.

You can reduce the waste media occurring the media set by expanding the media edge to roll core with the tape.

The procedure for reducing waste media is introduced below.

★ Important

- For this procedure, you need to set the media more accurately than the procedure described in the operating instructions. If the media is skewed, the print image quality significantly reduces.

Procedure

See the operating instructions, carry out the procedure until the media tip come out the cure heater and roll core is set on the roll-up unit.

Cut a strip about 1,000 mm (40 inches) long from the PVC media and attach one end to the center of the media using adhesive tape.

* You can also use commercially available tape

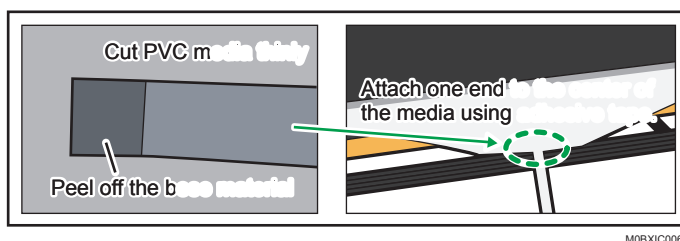

Rewind the media so that media tip place on the platen edge by rotating the roll holder on the back. At that moment, you must close the center cover and raise the media hold lever.

Pull the other end of the tape straight down and attach it to the roll core using adhesive tape as shown.

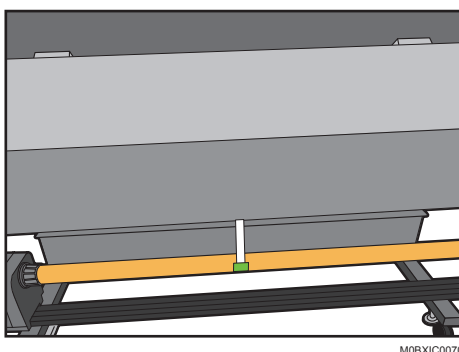

CIP Training L5160/L5130

Solutions

Carry out the latter procedure, seeing the operating instructions.

Begin inputting the media setting with the control panel.

Make sure the media is taut; otherwise, it may not be taken up correctly.

Referring to the section "Setting Media" in the manual "Operating Instructions" or the following video.

How to load the media:

<https://www.youtube.com/watch?v=aRqvMQCfMTg&feature=youtu.be>



MOBXIC0017

https://2280171.mediaspace.kaltura.com/media/How+to+set+media+on+the+Pro+L5130+series+of+wide+format+devices/1_mlm093yt

Reducing media consumption occurring Job to Job

If you want to reduce the waste media, change the setting for the "Auto Rewind after Drying". If you turn on this function, the machine automatically rewinds the media after drying to reduce the waste media between one job and next job (maximum 690 mm (27.2 inches)).

* Available with FW V1.07 or higher. If you cannot find this function, please contact your service representative.

Important

- Depending on the media, the image quality may be considerably degraded, so please test with the media in advance.

Solutions

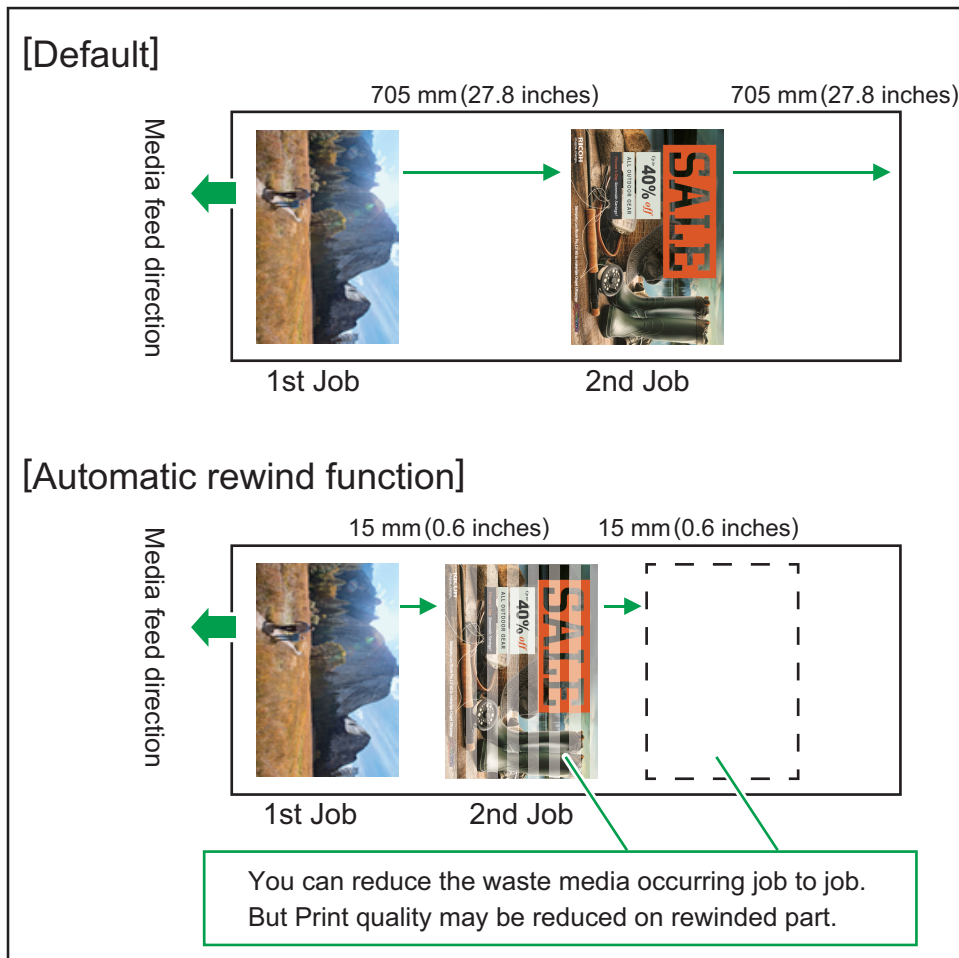

MOBXIC0071

* The above dimensions are approximate and cannot be guaranteed

How to change setting

[Print Adjustment] key ► [Media Settings] ► [Auto Rewind after Drying]

Media Settings Close

Vacuum Level

Auto Rewind after Drying

Auto Rewind after Auto Cut

Auto Rewind after Drying Close

Select an item.

If it is On, rewind the media 690 mm (27.2 inches) automatically after drying.

RICOH
imagine. change.