

CIP Training

Pro C9200 series

Adjustment Settings for Operators

RICOH
imagine. change.

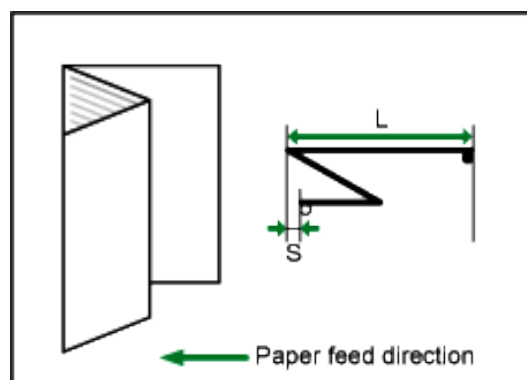
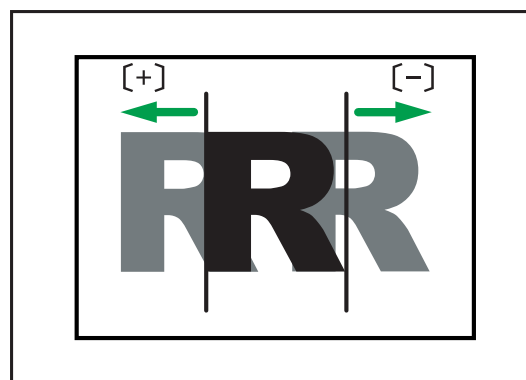

D1RC005

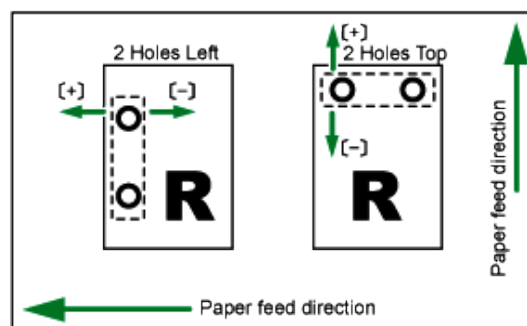

CV A003



Adjustment Settings for Operators

How to Use the [Adjustment Settings for Operators] Screen

This section explains how to use the Adjustment Settings for Operators.

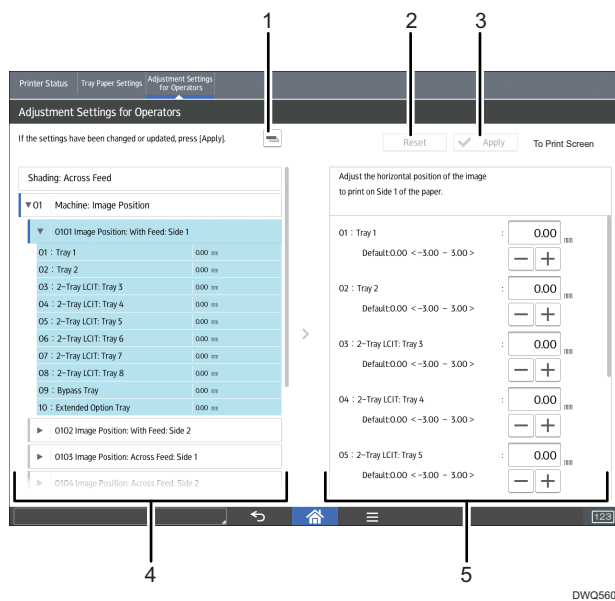

- 
Press this key to collapse the hierarchical display of the adjustment items, and display only the group names of those items.
- [Reset]
Press this key to reset the settings/modifications being currently configured. The settings/modifications cannot be reset after you press [Apply].
- [Apply]
Press this key to apply the settings/modifications.
- Adjustment items
Adjustment items are displayed in this area. When you select an item, its configuration screen will then open.
- Configuration screen
Configure or modify the settings of the adjustment item that you have selected.

Note

- All items in Adjustment Settings for Operators appear regardless of which of the machine's optional components are installed. If you change the settings of options that are not installed, the changes will have no effect.

Adjustment Settings for Operators

Opening Adjustment Settings for Operators

1. Press [Adjustment Settings for Operators] on the Home screen.
2. Select and change adjustment settings.
The method for changing the selected adjustment setting depends on the setting that you want to change. For details, see page 176 "Features of the Displayed Items and Setting Operations".
3. Press [Apply].
4. Press [Home] () at the bottom of the screen in the center.

Features of the Displayed Items and Setting Operations

The following operations are available for each adjustment item:

- Value setting
- Item setting
- Executing
- Display only

Value setting

Press [+] to increase the value, or [-] to decrease or use the numeric keypad to enter the value.

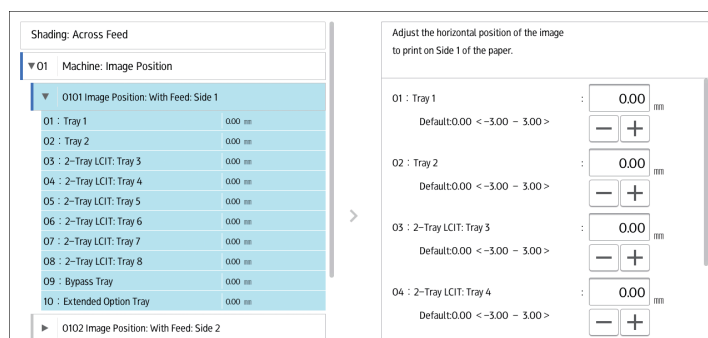

Adjustment Settings for Operators

For some settings, move the slider right or left to increase or decrease the setting value.

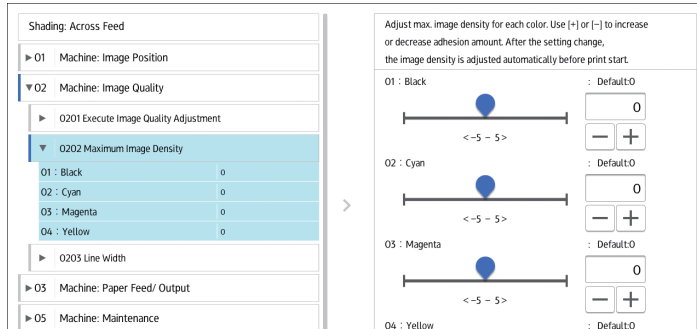

A numeric keypad appears to the left when you press the input box. Use the keypad to enter a value.

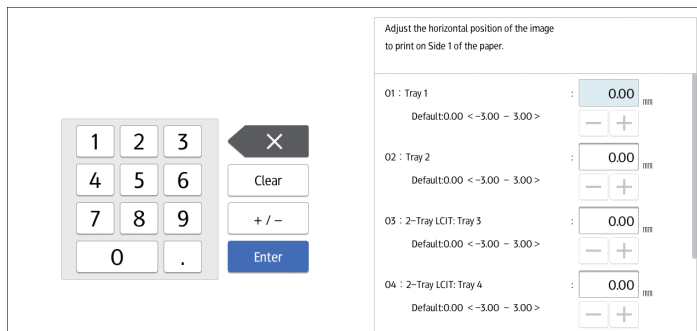

- [X]: Press to delete the entered value character by character.
- [Clear]: Clear the entered value.
- [+/-]: Change the sign of the entered value from + (positive) to - (negative) and vice versa.
- [Enter]: Confirm the entered value.

For some items, you can select a value from the pull-down list that appears when you press the input box. Select a value from the list.

CIP Training Pro C9200 series

Adjustment Settings for Operators

Item setting

Select the item you require.

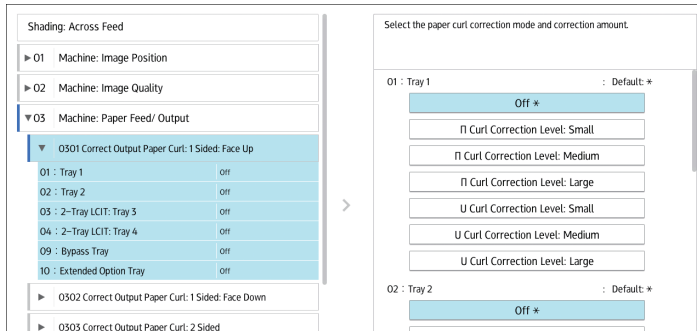

Executing

Press [Execute] to perform a selected function.

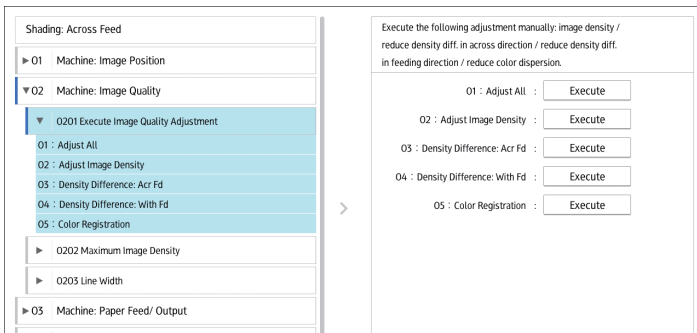

Display Only

You can check the setting of the selected item.

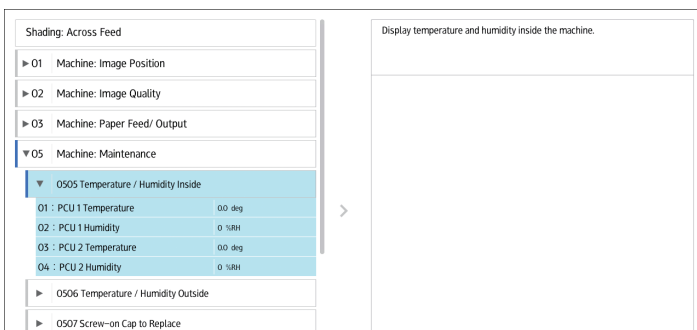

Adjustment Settings for Operators

Printing with Adjusted Settings

To print with the settings you have adjusted, be sure to select the paper tray and paper size to which the settings apply.

- Settings adjustable for each paper tray
- Settings adjustable for each paper size

Settings adjustable for each paper tray

- These are settings adjustable for each paper tray.
- Print jobs are processed with the adjusted settings when printing from a tray with the applied settings.

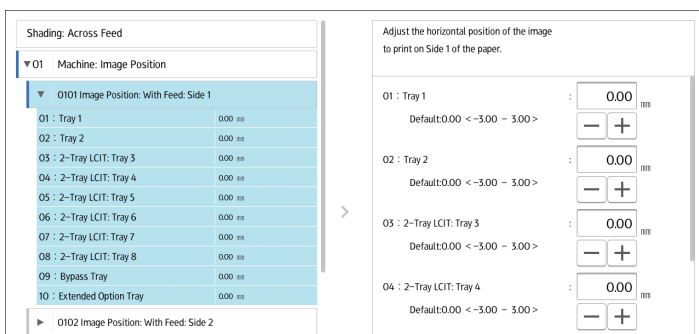

Settings adjustable for each paper size

- These are settings adjustable for each paper size.
- Print jobs are processed with the adjusted settings when printing with a paper size that has the applied settings.

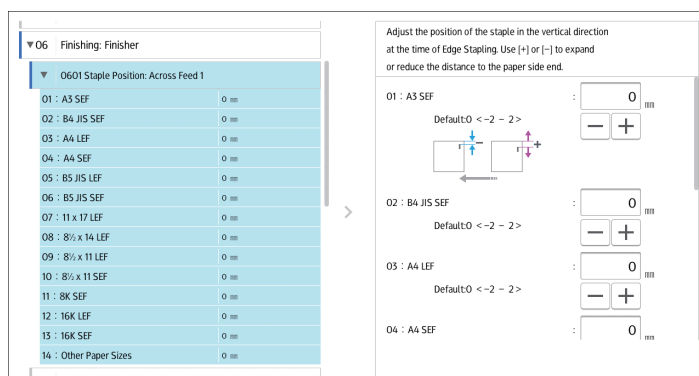

↓ Note

- For details about selecting the paper tray and paper size for printing, see the manuals for the related functions.

Adjustment Settings for Operators

Menu Items and Function

All items in Adjustment Settings for Operators appear regardless of which of the machine's optional components are installed. If you change the settings of options that are not installed, the changes will have no effect.

01: Machine: Image Position

0101 Image Position: With Feed: Side 1

Adjust the image position (left and right) on side 1 along the feeding direction.

Press [+] to shift the image position to the right (toward the bottom edge), or press [-] to shift the position to the left (toward the leading edge).

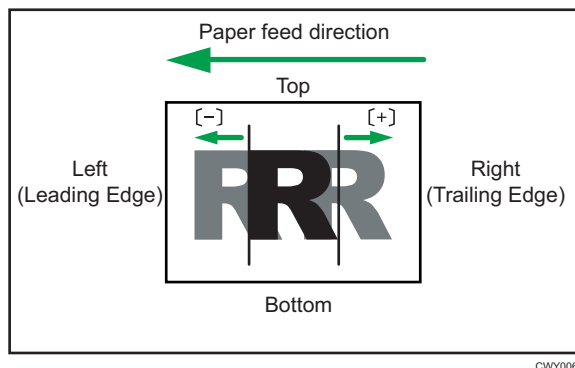

CWY006

Setting Items	Default Value	Max. Value	Min. Value	Step	Unit
Tray 1	0.00	3.00	-3.00	0.01	mm
Tray 2					
2-Tray LCIT: Tray 3					
2-Tray LCIT: Tray 4					
2-Tray LCIT: Tray 5					
2-Tray LCIT: Tray 6					
2-Tray LCIT: Tray 7					
2-Tray LCIT: Tray 8					
Bypass Tray					
Extended Option Tray					

↓ Note

- If sheets are delivered face down, turn them over horizontally and check the image position.

Adjustment Settings for Operators

- If the leading-edge margin on the side 1 of the paper is too narrow, paper jams may occur.
- If the trailing-edge margin on the side 1 of the paper is too narrow, paper jams may occur when printing on the back in duplex printing.

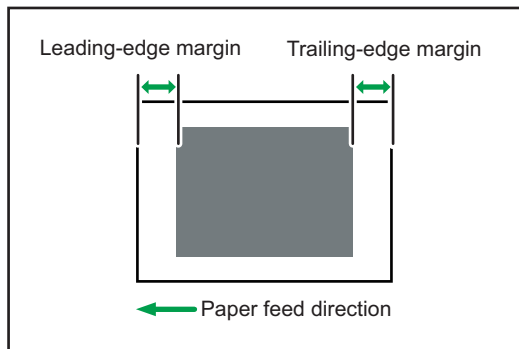

CWY015

- This setting is not effective for paper fed from paper trays with custom paper presets. For such paper, the value specified in [Image Position: Side1] in [Advanced Settings] takes precedence.

0102 Image Position: With Feed: Side 2

Adjust the image position (left and right) on side 2 along the feeding direction.

Press [+] to shift the image position to the left (toward the bottom edge), or press [-] to shift the position to the right (toward the leading edge).

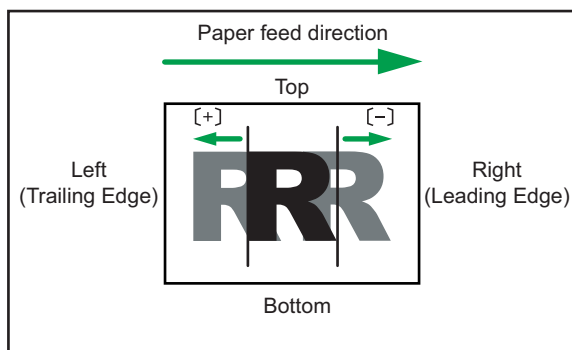

CWY014

Adjustment Settings for Operators

Setting Items	Default Value	Max. Value	Min. Value	Step	Unit
Tray 1	0.00	3.00	-3.00	0.01	mm
Tray 2					
2-Tray LCIT: Tray 3					
2-Tray LCIT: Tray 4					
2-Tray LCIT: Tray 5					
2-Tray LCIT: Tray 6					
2-Tray LCIT: Tray 7					
2-Tray LCIT: Tray 8					
Bypass Tray					
Extended Option Tray					

↓ Note

- If sheets are delivered face down, turn them over horizontally and check the image position.
- This setting is not effective for paper fed from paper trays with custom paper presets. For such paper, the value specified in [Image Position: Side2] in [Advanced Settings] takes precedence.

0103 Image Position: Across Feed: Side 1

Adjust the image position (up and down) on side 1 across the feeding direction. Press [+] or [-] to shift the image position upward (toward the back) or downward (toward the front).

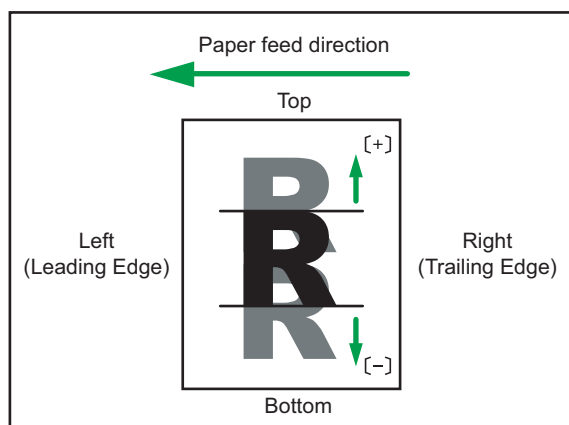

DGH005

Adjustment Settings for Operators

Setting Items	Default Value	Max. Value	Min. Value	Step	Unit
Tray 1	0.00	3.00	-3.00	0.01	mm
Tray 2					
2-Tray LCIT: Tray 3					
2-Tray LCIT: Tray 4					
2-Tray LCIT: Tray 5					
2-Tray LCIT: Tray 6					
2-Tray LCIT: Tray 7					
2-Tray LCIT: Tray 8					
Bypass Tray					
Extended Option Tray					

↓ Note

- If sheets are delivered face down, turn them over horizontally and check the image position.
- This setting is not effective for paper fed from paper trays with custom paper presets. For such paper, the value specified in [Image Position: Side1] in [Advanced Settings] takes precedence.

0104 Image Position: Across Feed: Side 2

Adjust the image position (up and down) on side 2 across the feeding direction. Press [] or [] to shift the image position upward (toward the back) or downward (toward the front).

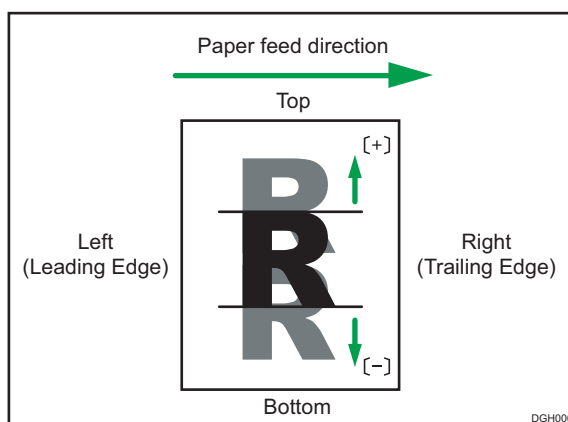

Adjustment Settings for Operators

Setting Items	Default Value	Max. Value	Min. Value	Step	Unit
Tray 1	0.00	3.00	-3.00	0.01	mm
Tray 2					
2-Tray LCIT: Tray 3					
2-Tray LCIT: Tray 4					
2-Tray LCIT: Tray 5					
2-Tray LCIT: Tray 6					
2-Tray LCIT: Tray 7					
2-Tray LCIT: Tray 8					
Bypass Tray					
Extended Option Tray					

Note

- If sheets are delivered face down, turn them over horizontally and check the image position.
- This setting is not effective for paper fed from paper trays with custom paper presets. For such paper, the value specified in [Image Position: Side2] in [Advanced Settings] takes precedence.

0105 Image Magnification: With Feed: Side 1

Adjust the horizontal image scaling to print on Side 1/2 of the paper according to the paper expansion or shrinkage.

Setting Items	Default Value	Max. Value	Min. Value	Step	Unit
Tray 1	0.000	0.500	-0.500	0.025	%
Tray 2					
2-Tray LCIT: Tray 3					
2-Tray LCIT: Tray 4					
2-Tray LCIT: Tray 5					
2-Tray LCIT: Tray 6					
2-Tray LCIT: Tray 7					
2-Tray LCIT: Tray 8					
Bypass Tray					
Extended Option Tray					

Note

- Depending on the setup, the print side with respect to the delivery and paper feed directions may vary.
- This setting is not effective for paper fed from paper trays with custom paper presets.

Adjustment Settings for Operators

0106 Image Magnification: With Feed: Side 2

Adjust the horizontal image scaling to print on Side 1/2 of the paper according to the paper expansion or shrinkage.

Setting Items	Default Value	Max. Value	Min. Value	Step	Unit
Tray 1	0.000	0.500	-0.500	0.025	%
Tray 2					
2-Tray LCIT: Tray 3					
2-Tray LCIT: Tray 4					
2-Tray LCIT: Tray 5					
2-Tray LCIT: Tray 6					
2-Tray LCIT: Tray 7					
2-Tray LCIT: Tray 8					
Bypass Tray					
Extended Option Tray					

Note

- Depending on the setup, the print side with respect to the delivery and paper feed directions may vary.
- This setting is not effective for paper fed from paper trays with custom paper presets.

0107 Image Magnification: Across Feed: Side 1

Adjust the vertical image scaling to print on Side 1/2 of the paper according to the paper expansion or shrinkage.

Setting Items	Default Value	Max. Value	Min. Value	Step	Unit
Tray 1	0.000	0.500	-0.500	0.001	%
Tray 2					
2-Tray LCIT: Tray 3					
2-Tray LCIT: Tray 4					
2-Tray LCIT: Tray 5					
2-Tray LCIT: Tray 6					
2-Tray LCIT: Tray 7					
2-Tray LCIT: Tray 8					
Bypass Tray					
Extended Option Tray					

Adjustment Settings for Operators

Note

- Depending on the setup, the print side with respect to the delivery and paper feed directions may vary.
- This setting is not effective for paper fed from paper trays with custom paper presets.

0108 Image Magnification: Across Feed: Side 2

Adjust the vertical image scaling to print on Side 1/2 of the paper according to the paper expansion or shrinkage.

Setting Items	Default Value	Max. Value	Min. Value	Step	Unit
Tray 1	0.000	0.500	-0.500	0.001	%
Tray 2					
2-Tray LCIT: Tray 3					
2-Tray LCIT: Tray 4					
2-Tray LCIT: Tray 5					
2-Tray LCIT: Tray 6					
2-Tray LCIT: Tray 7					
2-Tray LCIT: Tray 8					
Bypass Tray					
Extended Option Tray					

Note

- Depending on the setup, the print side with respect to the delivery and paper feed directions may vary.
- This setting is not effective for paper fed from paper trays with custom paper presets.

0109 Perpendicularity Adjustment

Adjust the image skew (perpendicularity) across the feeding direction.

Press [F] or [B] to tilt the image to the left (toward the top) or right (toward the bottom).

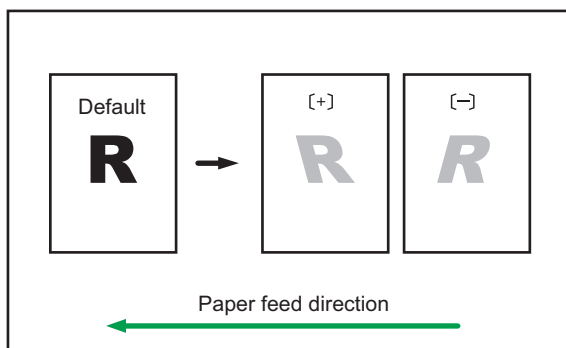

Adjustment Settings for Operators

Setting Items	Default Value	Max. Value	Min. Value	Step	Unit
Correction Value	0	20	-20	1	-

↓ Note

- After performing Perpendicularity Adjustment, execute [Color Registration] under 0201 [Execute Image Quality Adjustment] in Adjustment Settings for Operators.

0110 Switch Paper Edge Detection Sensor

Specify the level for detecting the paper edge for correcting the image position along the feeding direction.

Setting Items	Selection	Default Value
Tray 1	Normal	Normal
Tray 2	High Accuracy	
2-Tray LCIT: Tray 3		
2-Tray LCIT: Tray 4		
2-Tray LCIT: Tray 5		
2-Tray LCIT: Tray 6		
2-Tray LCIT: Tray 7		
2-Tray LCIT: Tray 8		
Bypass Tray		
Extended Option Tray		

↓ Note

- Select [High Accuracy] only when blank paper is fed. Otherwise, a paper jam may occur.

Adjustment Settings for Operators

Machine: Image Quality

0201 Execute Image Quality Adjustment

Execute image control or color registration adjustment manually.

The machine adjusts the image density. The time required for each process is as follows: about 5 minutes for [Adjust All], about 1.5 minutes for [Adjust Image Density], about 1 minute for [Density Difference: Acr Fd], about 2.5 minutes for [Density Difference: With Fd], and about 40 seconds for [Color Registration]. A message appears on the control panel while the process is in progress. Do not pull out the mainframe front covers while the message is being displayed.

Setting Items	Values
Adjust All	Press [Execute].
Adjust Image Density	
Density Difference: Acr Fd	
Density Difference: With Fd	
Color Registration	

Note

- The machine executes automatic image quality adjustment after a set interval or after printing a specified number of sheets. However, you can also manually initiate automatic image density adjustment whenever you want.

0202 Maximum Image Density

Adjust the toner adhesion amount to the intermediate transfer belt during the image density adjustment.

When the degree of coloration differs depending on the difference in the degree of pigmentation, adjust the toner adhesion amount.

Press [+] or [-] to increase or decrease the toner adhesion amount.

If you change the setting value, [Adjust Image Density] is automatically performed before the machine starts printing.

Setting Items	Default Value	Max. Value	Min. Value	Step	Unit
Black	0	5	-5	1	-
Cyan					
Magenta					
Yellow					

Note

- Increasing the toner adhesion might reduce fusibility, causing toner splatter or distorted text and thin lines.

Adjustment Settings for Operators

0203 Line Width

Adjust the intensity of the laser for rasterizing the image data. Press [+] or [-] to increase or decrease the intensity.

If you change the setting value, [Adjust Image Density] is automatically performed before the machine starts printing.

Setting Items	Default Value	Max. Value	Min. Value	Step	Unit
Black	0	5	-5	1	-
Cyan					
Magenta					
Yellow					

Note

- Screen dots and hairline width become thicker when you increase the intensity.

Machine: Paper Feed/ Output

0301 Correct Output Paper Curl: 1 Sided: Face Up

Specify the method for straightening paper curls on 1-sided face-up output sheets. Select the method according to the direction and degree of curl.

Setting Items	Selection	Default Value
Tray 1	Off	Off
Tray 2	Π Curl Correction	
2-Tray LCIT: Tray 3	Level: Small	
2-Tray LCIT: Tray 4	Π Curl Correction	
2-Tray LCIT: Tray 5	Level: Medium	
2-Tray LCIT: Tray 6	Π Curl Correction	
2-Tray LCIT: Tray 7	Level: Large	
2-Tray LCIT: Tray 8	U Curl Correction	
2-Tray LCIT: Tray 8	Level: Small	
Bypass Tray	U Curl Correction	
Extended Option Tray	Level: Medium	
	U Curl Correction	
	Level: Large	

Adjustment Settings for Operators

0303 Correct Output Paper Curl: 2 Sided

Specify the method for straightening paper curls on 2-sided output sheets.

Select the method according to the direction and degree of curl.

Setting Items	Selection	Default Value
Tray 1	Off	Off
Tray 2	□ Curl Correction Level: Small	
2-Tray LCIT: Tray 3	□ Curl Correction Level: Medium	
2-Tray LCIT: Tray 4	□ Curl Correction Level: Large	
2-Tray LCIT: Tray 5	U Curl Correction Level: Small	
2-Tray LCIT: Tray 6	U Curl Correction Level: Medium	
2-Tray LCIT: Tray 7	U Curl Correction Level: Large	
2-Tray LCIT: Tray 8		
Bypass Tray		
Extended Option Tray		

0304 Detect JAM099

Specify whether or not to detect double feed (multi-sheet feeding).

If this is set to [On], the machine can detect double feeding, which prevents blank sheets turning up in the delivered paper.

The machine may erroneously detect double feeding when using special paper (double-layer paper, such as label paper). If such erroneous detection occurs, set this to [Off].

This setting is invalid when you are printing from the tray for which custom paper is allocated. For such paper, the value specified in [Detect JAM099] in [Advanced Settings] takes precedence.

Setting Items	Selection	Default Value
Tray 1	Off	On
Tray 2	On	
2-Tray LCIT: Tray 3		
2-Tray LCIT: Tray 4		
2-Tray LCIT: Tray 5		
2-Tray LCIT: Tray 6		
2-Tray LCIT: Tray 7		
2-Tray LCIT: Tray 8		
Bypass Tray		
Extended Option Tray		

CIP Training Pro C9200 series

Adjustment Settings for Operators

0305 Detect JAM080

Specify whether or not to detect error as a paper jam when the image deviation in the feeding direction exceeds a certain degree.

Setting Items	Values	Default Value
Tray 1	Off	On
Tray 2	On	
2-Tray LCIT: Tray 3		
2-Tray LCIT: Tray 4		
2-Tray LCIT: Tray 5		
2-Tray LCIT: Tray 6		
2-Tray LCIT: Tray 7		
2-Tray LCIT: Tray 8		
Bypass Tray		
Extended Option Tray		

0306 Detect J097/098

Specify whether or not to detect error as a paper jam when a deviation or paper skew across the feeding direction is detected.

Setting Items	Values	Default Value
Tray 1	Off	On
Tray 2	On	
2-Tray LCIT: Tray 3		
2-Tray LCIT: Tray 4		
2-Tray LCIT: Tray 5		
2-Tray LCIT: Tray 6		
2-Tray LCIT: Tray 7		
2-Tray LCIT: Tray 8		
Bypass Tray		
Extended Option Tray		

CIP Training Pro C9200 series

Adjustment Settings for Operators

0307 Control J097/098

Specify whether or not to correct an image position and skew across the feeding direction.

Setting Items	Values	Default Value
Tray 1	Off	On
Tray 2	On	
2-Tray LCIT: Tray 3		
2-Tray LCIT: Tray 4		
2-Tray LCIT: Tray 5		
2-Tray LCIT: Tray 6		
2-Tray LCIT: Tray 7		
2-Tray LCIT: Tray 8		
Bypass Tray		
Extended Option Tray		

0308 Detect JAM048

Specify whether or not to detect an error as a paper jam when a problem is detected while the registration mark is checked for image position correction.

Setting Items	Values	Default Value
Setting	Off On	On

Adjustment Settings for Operators

Machine: Maintenance

0505 Temperature / Humidity Inside

Display the internal temperature and humidity.

Report this information if your service representative requests it.

Setting Items	Remarks
PCU 1 Temperature	Value display only.
PCU 1 Humidity	
PCU 2 Temperature	
PCU 2 Humidity	

0506 Temperature / Humidity Outside

Display the external temperature and humidity.

Report this information if your service representative requests it.

Setting Items	Remarks
Temperature	Value display only.
Humidity	

0507 Screw-on Cap to Replace

Close the Toner Bottle Cap.

The Toner Bottle in use can be pulled out when the Cap is closed. Use it when you want to replace the Toner Bottle.

Setting Items	Description
Black 1	Press [Execute] to execute the function. Open the toner bottle cover (the cover of the toner dispensing section) before executing this function. Afterward, remove the toner bottle by pushing the knob below the bottle.
Black 2	
Cyan 1	
Cyan 2	
Magenta 1	
Magenta 2	
Yellow 1	
Yellow 2	

Adjustment Settings for Operators

0508 Execute Developer Refreshing

The machine uses degraded toner in the development unit and adds new toner from the toner bottle. Refresh the toner for print jobs if:

- Background is dirty
- White spots appear
- Density is uneven
- Black parts are faded

Setting Items	Values
All Colors Black	Press [Execute].

0509 Execute Photoconductor Refreshing

Remove dust on the drum surface.

This operation takes about four minutes. Do not open the right or left mainframe front cover during operation.

Setting Items	Selection
Execute	Press [Execute].

0510 Execute Charger Unit Cleaning

Cleans the Charge Unit.

Execute this function when vertical streaks appear on the printed page.

Setting Items	Description
All Colors Black Cyan Magenta Yellow	Press [Execute] to execute the function. Keep the front cover of the main unit closed until the process is completed.

Adjustment Settings for Operators

0512 Fusing Belt Smoothing Setting

Specify the condition to execute Fuser Belt smoothing.

Setting Items	Selection	Default Value
Auto Exe: Belt Scratches	Off Automatic Execution Most Frequently Automatic Execution: Set by User	Automatic Execution
Feed Speed	High Middle Low 1 Low 2 Low 3	Low 3

0513 Smooth Fusing Belt

Smooth the Fuser Belt to remove vertical and horizontal lines from the printouts.

Vertical or horizontal lines may appear when printing on paper that is larger than the paper used immediately before it.

In such case, press [Execute] to cause a roller to press on the fusing belt and prevent vertical and horizontal lines. Select [Belt Scratches] if vertical or horizontal lines appear on the edges of the paper. Select [Uneven Gloss: Short Time] if there are patches of uneven glossiness.

Setting Items	Selection
Belt Scratches Uneven Gloss: Short Time	Press [Execute].

0516 Manage Multiple Fusing Units by Counter

Display the counter of Fusing Unit parts.

Setting Items	Selection	Default Value
Fuser Unit No.	Unit 1 Unit 2 Unit 3 Unit 4	Unit 1

Adjustment Settings for Operators

Setting Items	Remarks
Curt:Dist:Fuser Unit	Value display only.
Curt:Dist:Fusing Belt	Saved Value specified in Fuser Unit No. is displayed under Current Value.
Curt:Dist:Fusing Rllr	
Curt:Dist:Press Rllr	
Curt:Dist:Thermistor	
Curt:Dist:Separation Pad	
Curt:Dist:Fusing Heater	
Curt:Dist:Gear Set	
Curt:Page:Fuser Unit	
Curt:Page:Fusing Belt	
Curt:Page:Fusing Rllr	
Curt:Page:Press Rllr	
Curt:Page:Thermistor	
Curt:Page:Separation Pad	
Curt:Page:Fusing Heater	
Curt:Page:Gear Set	
Curt:Paper Feed :Clng Web	
Curt:Rot:Clng Web	
Curt:Smooting Time	

Finishing: Finisher

0601 Staple Position: Across Feed 1

Adjust the vertical position of the staple (applied at an edge) when using Finisher SR5050 or Booklet Finisher SR5060.

Press [+] to move the stapling position away from the side edge of the sheet or [-] to move it toward the edge.

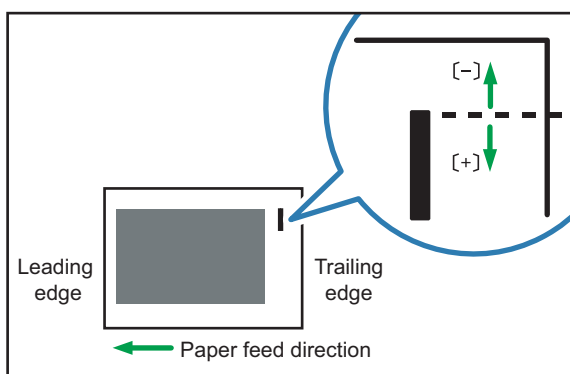

Adjustment Settings for Operators

Setting Items	Default Value	Max. Value	Min. Value	Step	Unit
A3 SEF	0	2	-2	1	mm
B4 JIS SEF					
A4 LEF					
A4 SEF					
B5 JIS LEF					
B5 JIS SEF					
11 × 17 SEF					
8 ¹ / ₂ × 14 SEF					
8 ¹ / ₂ × 11 LEF					
8 ¹ / ₂ × 11 SEF					
8K SEF					
16K LEF					
16K SEF					
Other Paper Sizes					

0602 Staple Position: Across Feed 2

Adjust the vertical distance (up and down) between the staples (dual) when using Finisher SR5050 or Booklet Finisher SR5060.

Press [+] to move the two stapling positions away from the center and each other or [-] to move them toward each other.

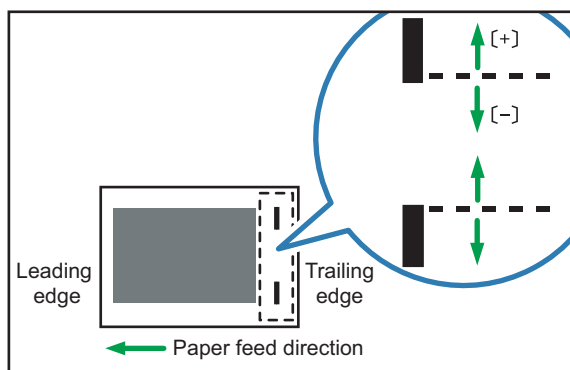

DFZ002

Adjustment Settings for Operators

Setting Items	Default Value	Max. Value	Min. Value	Step	Unit
A3 SEF	0	115	-16	1	mm
B4 JIS SEF		75			
A4 LEF		115			
A4 SEF		28			
B5 JIS LEF		75			
B5 JIS SEF		0			
11 × 17 SEF		98			
8 ¹ / ₂ × 14 SEF		34			
8 ¹ / ₂ × 11 LEF		98			
8 ¹ / ₂ × 11 SEF		34			
8K SEF		85			
16K LEF					
16K SEF		12			
Other Paper Sizes		115			

0603 Staple Position: With Feed

Adjust the horizontal position of the staples when using Finisher SR5050 or Booklet Finisher SR5060.

Press [+] to move the stapling position away from the trailing edge of the sheet or [-] to move it toward the edge.

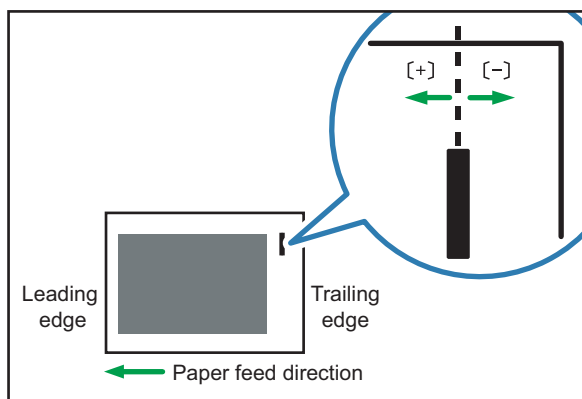

DFZ003

Adjustment Settings for Operators

Setting Items	Default Value	Max. Value	Min. Value	Step	Unit
A3 SEF	0	2	-2	1	mm
B4 JIS SEF					
A4 LEF					
A4 SEF					
B5 JIS LEF					
B5 JIS SEF					
11 × 17 SEF					
8 ¹ / ₂ × 14 SEF					
8 ¹ / ₂ × 11 LEF					
8 ¹ / ₂ × 11 SEF					
8K SEF					
16K LEF					
16K SEF					
Other Paper Sizes					

0604 Paper Alignment for Stapling: Across Feed

Adjust the width of the Staple Jogger*1 when using the staple function on Finisher SR5050 or Booklet Finisher SR5060.

Use the function to reduce the dispersion of paper orientation at a right angle due to paper size, thickness, curl and so on.

Press [+] or [-] to increase or decrease the width.

Setting Items	Default Value	Max. Value	Min. Value	Step	Unit
A3 SEF	0.0	1.0	-1.0	0.1	mm
B4 JIS SEF					
A4 LEF					
A4 SEF					
B5 JIS LEF					
B5 JIS SEF					
11 × 17 SEF					
8 ¹ / ₂ × 14 SEF					
8 ¹ / ₂ × 11 LEF					
8 ¹ / ₂ × 11 SEF					
8K SEF					
16K LEF					
16K SEF					
Other Paper Sizes					

Adjustment Settings for Operators

0605 Paper Alignment for Stapling: With Feed

Adjust the Tip Stopper movement when using the staple function applied at an angle on Finisher SR5050 or Booklet Finisher SR5060.

Use the function to reduce the dispersion of paper orientation in the feeding direction due to paper size, thickness, curl and so on.

Press [+] or [-] to increase or decrease the amount of movement.

Setting Items	Default Value	Max. Value	Min. Value	Step	Unit
A3 SEF	0.0	2.5	-2.5	0.1	mm
B4 JIS SEF					
A4 LEF					
A4 SEF					
B5 JIS LEF					
B5 JIS SEF					
11 × 17 SEF					
8 ¹ / ₂ × 14 SEF					
8 ¹ / ₂ × 11 LEF					
8 ¹ / ₂ × 11 SEF					
8K SEF					
16K LEF					
16K SEF					
Other Paper Sizes					

0606 Number of Sheets Align for Stapling

Specify the number of sheets to align for stapling at one time.

If too many sheets are delivered to the shift unit, the stacked sheets may not be correctly aligned due to the paper type and paper condition.

If that happens, adjust the setting to the optimal value for the paper you are using.

When the number is less, it takes more time to align and productivity may fall.

Adjustment Settings for Operators

Setting Items	Default Value	Max. Value	Min. Value	Step	Unit
A3 SEF B4 JIS SEF	4	4	0	1	sheet
A4 LEF	6	6			
A4 SEF	4	4			
B5 JIS LEF	6	6			
B5 JIS SEF 11 × 17 SEF 8 ¹ / ₂ × 14 SEF	4	4			
8 ¹ / ₂ × 11 LEF	6	6			
8 ¹ / ₂ × 11 SEF 8K SEF	4	4			
16K LEF	6	6			
16K SEF	4	4			
Other Paper Sizes	4	9			

0607 Punch Position: Across Feed

Adjust the vertical position of the punch holes when using Finisher SR5050 or Booklet Finisher SR5060. Press [+] to move the position forward (up), or [-] to move it backward (down).

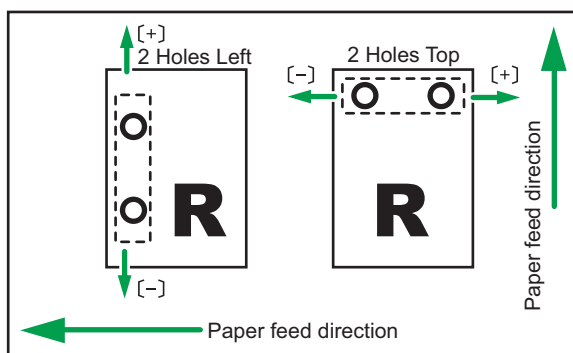

Adjustment Settings for Operators

Setting Items	Default Value	Max. Value	Min. Value	Step	Unit
2 Holes JP / EU	0.0	2.0	-2.0	0.5	mm
3 Holes US					
4 Holes EU					
4 Holes NE					
2 Holes US					

0608 Punch Position: With Feed

Adjust the horizontal position of the punch holes when using Finisher SR5050 or Booklet Finisher SR5060.

Press [+] to move the position toward the top edge (left) relative to the paper feed direction, or [-] to move it toward the bottom edge (right).

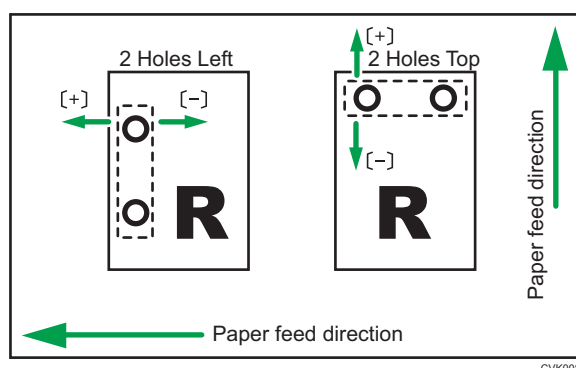

Setting Items	Default Value	Max. Value	Min. Value	Step	Unit
2 Holes JP / EU	0.0	4.0	-4.0	0.5	mm
3 Holes US					
4 Holes EU					
4 Holes NE					
2 Holes US					

0609 Punch Skew Correction

Specify whether or not to correct the punch skew when using Finisher SR5050 or Booklet Finisher SR5060.

Adjustment Settings for Operators

If jamming or ear-fold occurs at the punch section especially when thin paper is used, set it to [No].

Setting Items	Values	Default Value
Setting	Off On	On

0610 Amount of Punch Skew Correction

Adjust the level of skew correction when using Finisher SR5050 or Booklet Finisher SR5060. Use the function to reduce the punch skewing caused by paper size, thickness, curl and so on. To skew while punching, set [+] to increase the correction level.

Setting Items	Default Value	Max. Value	Min. Value	Step	Unit
A4 LEF	0.0	1.0	-1.0	0.5	mm
B5 JIS LEF					
A5 LEF					
A5 SEF					
8 ¹ / ₂ × 11 LEF					
5 ¹ / ₂ × 8 ¹ / ₂ LEF					
5 ¹ / ₂ × 8 ¹ / ₂ SEF					
Other Paper Sizes					

0611 Paper Alignment in Shift Tray Setting

Specify the alignment precision of output sheets during Shift Sorting when using Finisher SR5050 or Booklet Finisher SR5060.

Use this function when the topmost sheet of the stacked paper is skewed.

Select [Accuracy Priority] to lower the shifting speed of the tray to reduce the skew caused by inertia.

Setting Items	Values	Default Value
Setting	Speed Priority Accuracy Priority	Speed Priority

Adjustment Settings for Operators

0612 Paper Alignment in Shift Tray: Across Feed

Adjust the width of Paper Alignment Jogger*¹ on the Shift Tray when sheets are ejected and delivered to the Shift Tray of Finisher SR5050 or Booklet Finisher SR5060.

Use the function to reduce the dispersion of paper orientation at a right angle due to paper size, thickness, curl and so on.

Press [+] or [-] to increase or decrease the width.

Setting Items	Default Value	Max. Value	Min. Value	Step	Unit
A3 SEF	0.0	1.0	-1.0	0.1	mm
B4 JIS SEF					
A4 LEF					
A4 SEF					
B5 JIS LEF					
B5 JIS SEF					
A5 LEF					
A5 SEF					
11 × 17 SEF					
8 ¹ / ₂ × 14 SEF					
8 ¹ / ₂ × 11 LEF					
8 ¹ / ₂ × 11 SEF					
5 ¹ / ₂ × 8 ¹ / ₂ LEF					
5 ¹ / ₂ × 8 ¹ / ₂ SEF					
Other Paper Sizes					

*1 A guide for aligning output sheets when using the shift function. The guide is located inside the finisher.

0613 Output Tray Descending Position

Specify the tray descent range according to the paper weight when sheets are ejected and delivered to the Shift Tray of Finisher SR5050 or Booklet Finisher SR5060.

The machine lowers the Paper Exit Guide each time it ejects stapled sheets. If the descent range is not appropriate for the paper weight, it may cause the paper to be improperly ejected or a diversion of sheets on the tray. Select the descent range appropriate for the paper you are using.

Setting Items	Values	Default Value
Setting	Paper Weight 1 Paper Weight 2 Paper Weight 3-8	Paper Weight 1

Adjustment Settings for Operators

0614 Exit Guide Close Timing

Specify the timing to close the Paper Exit Guide when sheets are ejected and delivered to the Shift Tray of Finisher SR5050 or Booklet Finisher SR5060.

The machine opens and closes the Paper Exit Guide each time it ejects stapled sheets. If the Paper Exit Guide does not open and close at a proper timing, bending may occur with the stapled stack when stapled sheets fail to be properly ejected. Select the timing appropriate for the paper you are using.

Setting Items	Values	Default Value
Setting	Default Thin Paper	Default

0615 Output Trail Edge Press Setting

Specify whether or not to hold the trailing edge of sheets when they are ejected and delivered to the Shift Tray of Finisher SR5050 or Booklet Finisher SR5060.

If too many sheets are delivered to the Shift Tray, the Ejected sheets may not be correctly aligned due to the paper type and paper condition.

Setting it to [On] reduces the diversion of sheets.

Setting Items	Values	Default Value
Setting	Auto On Off	Auto

0616 Output Fan Setting

Specify the fan operation to the sheets on the Shift Tray when sheets are ejected and delivered to the Shift Tray of Finisher SR5050 or Booklet Finisher SR5060.

Blowing air peels off the sheets in close contact.

Setting Items	Values	Default Value
Setting	Auto On Off	Auto

Adjustment Settings for Operators

0617 Output Fan Level

Specify the air flow of the fan on the Shift Tray when sheets are ejected and delivered to the Shift Tray of Finisher SR5050 or Booklet Finisher SR5060.

Increase the level if the sheets ejected on the Shift Tray are in close contact.

Setting Items	Values	Default Value
Setting	Standard Increase Air Volume	Standard

0618 Staple Position for Booklet

Adjust the horizontal position of the booklet staples when using Booklet Finisher SR5060. Press [+] to move the position left, or press [-] to move it right on the open booklet.

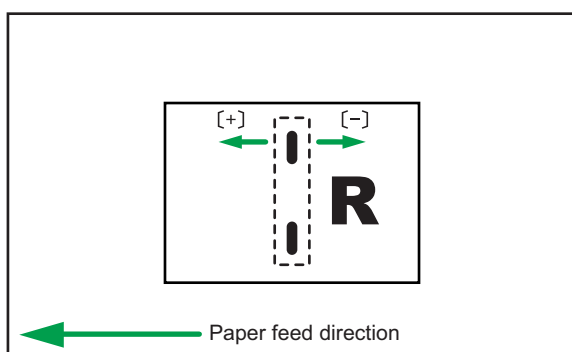

Setting Items	Default Value	Max. Value	Min. Value	Step	Unit
A3 SEF	0.0	1.0	-1.0	0.1	mm
B4 JIS SEF					
A4 SEF					
B5 JIS SEF					
SRA3 SEF					
SRA4 SEF					
13 × 19 ¹ / ₅ SEF					
13 × 19 SEF					
13 × 18 SEF					
12 ³ / ₅ × 19 ¹ / ₅ SEF					
12 ³ / ₅ × 18 ¹ / ₂ SEF					
12 × 18 SEF					
11 × 17 SEF					
8 ¹ / ₂ × 14 SEF					
8 ¹ / ₂ × 11 SEF					
226 × 310mm SEF					
310 × 432mm SEF					
Other Paper Sizes					

Adjustment Settings for Operators

0619 Folding Position for Booklet

Adjust the horizontal position of the folding when using Booklet Finisher SR5060. Press [] to move the position left or press [] to move it right on the open booklet.

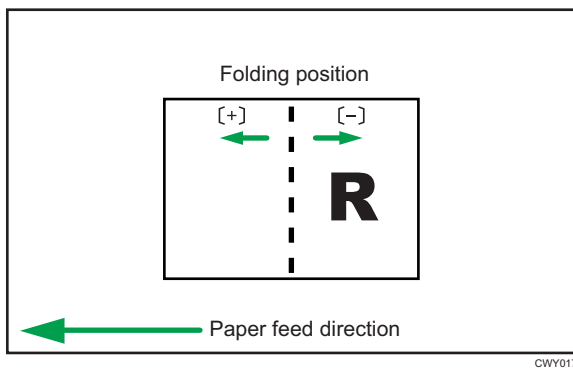

Setting Items	Default Value	Max. Value	Min. Value	Step	Unit
A3 SEF	0.0	1.0	-1.0	0.1	mm
B4 JIS SEF					
A4 SEF					
B5 JIS SEF					
SRA3 SEF					
SRA4 SEF					
13 × 19 ¹ / ₅ SEF					
13 × 19 SEF					
13 × 18 SEF					
12 ³ / ₅ × 19 ¹ / ₅ SEF					
12 ³ / ₅ × 18 ¹ / ₂ SEF					
12 × 18 SEF					
11 × 17 SEF					
8 ¹ / ₂ × 14 SEF					
8 ¹ / ₂ × 11 SEF					
226 × 310 mm SEF					
310 × 432 mm SEF					
Other Paper Sizes					

Adjustment Settings for Operators

0620 Paper Alignment for Booklet: Across Feed

Adjust the width of the Staple Jogger^{*1} when using Booklet Finisher SR5060.

Use the function to reduce the dispersion of paper orientation at a right angle due to paper size, thickness, curl and so on.

Press [+] or [-] to increase or decrease the width.

Setting Items	Default Value	Max. Value	Min. Value	Step	Unit
A3 SEF	0.0	0.5	-0.5	0.1	mm
B4 JIS SEF					
A4 SEF					
B5 JIS SEF					
SRA3 SEF					
SRA4 SEF					
13 × 19 ¹ / ₅ SEF					
13 × 19 SEF					
13 × 18 SEF					
12 ³ / ₅ × 19 ¹ / ₅ SEF					
12 ³ / ₅ × 18 ¹ / ₂ SEF					
12 × 18 SEF					
11 × 17 SEF					
8 ¹ / ₂ × 14 SEF					
8 ¹ / ₂ × 11 SEF					
226 × 310 mm SEF					
310 × 432 mm SEF					
Other Paper Sizes					

*1 A guide for aligning output sheets when using the stapling function. The guide is located inside the finisher.

Adjustment Settings for Operators

0621 Set Number of Folds for Booklet

Specify the number of booklet folds to be performed when using Booklet Finisher SR5060. You can adjust the paper folding strength by changing the number of folds per the booklet.

When you select "0", the default value, the finisher folds the booklet according to the number of sheets in the booklet, as shown below.

- 1–13 sheets: 1 time
- 14–15 sheets: 2 times
- 16–25 sheets: 3 times

The value set here is added to the default values, which are 1, 2, and 3. Set a negative value to reduce the number of times the finisher folds booklets. Set -1, -2, or -3 to not fold booklets that have 1 to 13 sheets, 14 to 15 sheets, or 16 to 25 sheets, respectively.

Setting Items	Default Value	Max. Value	Min. Value	Step	Unit
Setting	0	9	-3	1	times

0622 Paper Alignment for Booklet: With Feed

Adjust the Tip Stopper movement when using the booklet binding function on Finisher SR5050 or Booklet Finisher SR5060.

Use the function to reduce the dispersion of paper orientation in the feeding direction due to paper size, thickness, curl and so on.

Press [+] or [-] to increase or decrease the amount of movement.

CIP Training Pro C9200 series

Adjustment Settings for Operators

Setting Items	Default Value	Max. Value	Min. Value	Step	Unit
A3 SEF	0.0	2.0	-2.0	0.2	mm
B4 JIS SEF					
A4 SEF					
B5 JIS SEF					
SRA3 SEF					
SRA4 SEF					
13 × 19 ¹ / ₅ SEF					
13 × 19 SEF					
13 × 18 SEF					
12 ³ / ₅ × 19 ¹ / ₅ SEF					
12 ³ / ₅ × 18 ¹ / ₂ SEF					
12 × 18 SEF					
11 × 17 SEF					
8 ¹ / ₂ × 14 SEF					
8 ¹ / ₂ × 11 SEF					
Other Paper Sizes					

0623 Z-fold Skew Correction

Select the method to correct the skew during Z-folding on the fold unit. Selecting [No] disables skew correction.

Selecting [Yes] enables correction by striking.

[On: Reverse (Default)] corrects by both striking and reverse rotation of Registration Roller.

CIP Training Pro C9200 series

Adjustment Settings for Operators

Setting Items	Values	Default Value
Set	Off On On: Reverse (Default)	On: Reverse (Default)

0624 Amount of Z-fold Skew Correction

Adjust the striking amount of paper during Z-folding skew correction. Use this function when Z-folding skew correction causes a side effect.

The default striking amount "0.0" is set to 9 millimeters. Press [-] to reduce the striking amount. The amount becomes 0 millimeter when the value is "-9.0".

Setting Items	Default Value	Max. Value	Min. Value	Step	Unit
Set	0.0	0.0	-9.0	0.5	mm

0625 Amount of Z-fold Skew Correction: Reverse

Adjust the reverse rotation amount of Registration Roller during Z-folding skew correction. Use this function when Z-folding skew correction causes a side effect.

The default reverse rotation amount "0.0" is set to 3 millimeters. Press [-] to reduce the reverse rotation amount. The amount becomes "0" millimeter when the value is "-3.0".

Setting Items	Default Value	Max. Value	Min. Value	Step	Unit
Set	0.0	0.0	-3.0	0.5	mm

0626 Maximum No. Stacked Sheets in Output Tray

Specify the number of sheets to stack on the Shift Tray at the time of shift sorting. To avoid paper jams, specify the number according to the paper size.

CIP Training Pro C9200 series

Adjustment Settings for Operators

Setting Items	Values	Default Value
Paper Length ≤ 216	Default 1500 Sheets 1000 Sheets	Default
$216 < \text{Paper Length} \leq 432$	Default 1000 Sheets 500 Sheets	Default
$432 < \text{Paper Length}$	Default 500 Sheets	Default

Finishing: Fold

0701 Z-fold Position 1

Adjust the fold position of the end segment (S) when using the fold unit.

Press [+] to increase and [-] to reduce (S).

The ○ mark indicates the leading edge (relative to the paper feed direction), and the ● mark indicates the trailing edge.

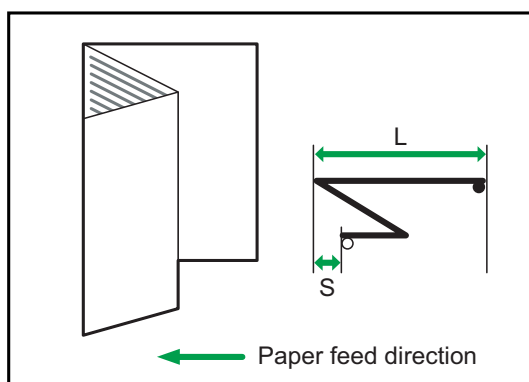

DWP561

Adjustment Settings for Operators

Setting Items	Default Value	Max. Value	Min. Value	Step	Unit
A3 SEF	0.0	4.0	-4.0	0.2	mm
B4 JIS SEF					
A4 SEF					
12 × 18 SEF					
11 × 17 SEF					
8 ¹ / ₂ × 14 SEF					
8 ¹ / ₂ × 11 SEF					
8K SEF					
Other Paper Sizes					

0702 Z-fold Position 2

Adjust the overall fold size (L) of the Z-foldout sheets when using the fold unit.

Press [+] to increase and [-] to reduce (L).

The ○ mark indicates the leading edge (relative to the paper feed direction), and the ● mark indicates the trailing edge.

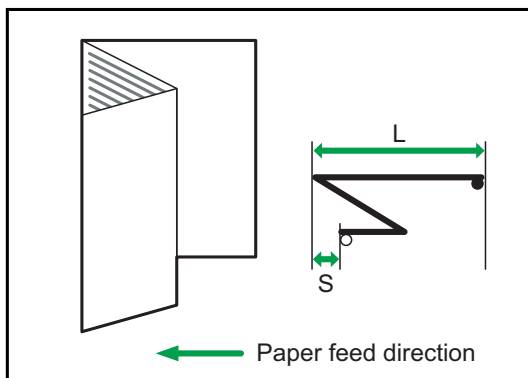

DWP561

Adjustment Settings for Operators

Setting Items	Default Value	Max. Value	Min. Value	Step	Unit
A3 SEF	0.0	4.0	-4.0	0.2	mm
B4 JIS SEF					
A4 SEF					
12 × 18 SEF					
11 × 17 SEF					
8 ¹ / ₂ × 14 SEF					
8 ¹ / ₂ × 11 SEF					
8K SEF					
Other Paper Sizes					

0703 Half Fold Position: 1 sheet Fold

Adjust the edge width of the half folded sheets (1 sheet fold) when using the fold unit.

Press [+] to increase and [-] to reduce (S).

This setting will be applied if the single-sheet fold function is enabled.

The ○ mark indicates the leading edge (relative to the paper feed direction), and the ● mark indicates the trailing edge.

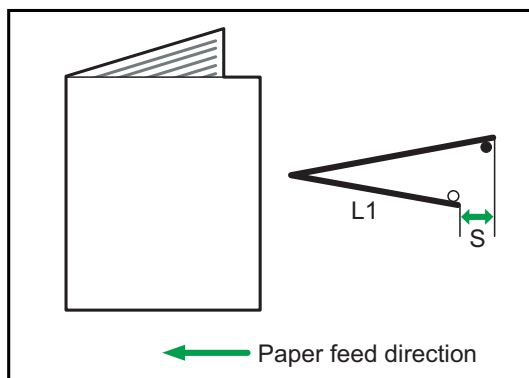

DWP562

CIP Training Pro C9200 series

Adjustment Settings for Operators



Setting Items	Default Value	Max. Value	Min. Value	Step	Unit
A3 SEF	0.0	4.0	-4.0	0.2	mm
B4 JIS SEF					
A4 SEF					
B5 JIS SEF					
SRA3 SEF					
SRA4 SEF					
310 × 432mm SEF					
226 × 310mm SEF					
13 × 19 ¹ / ₅ SEF					
13 × 19 SEF					
13 × 18 SEF					
12 ³ / ₅ × 19 ¹ / ₅ SEF					
12 ³ / ₅ × 18 ¹ / ₂ SEF					
12 × 18 SEF					
11 × 17 SEF					
8 ¹ / ₂ × 14 SEF					
8 ¹ / ₂ × 11 SEF					
8K SEF					
Other Paper Sizes					

0704 Half Fold Position: Multi-sheet Fold

Adjust the edge width of the half folded sheets (multi-sheet fold) when using the fold unit.

This setting will be applied if the multi-sheet fold function is enabled.

Press [+] to increase and [-] to reduce (S).

The  mark indicates the leading edge (relative to the paper feed direction), and the  mark indicates the trailing edge.

Adjustment Settings for Operators

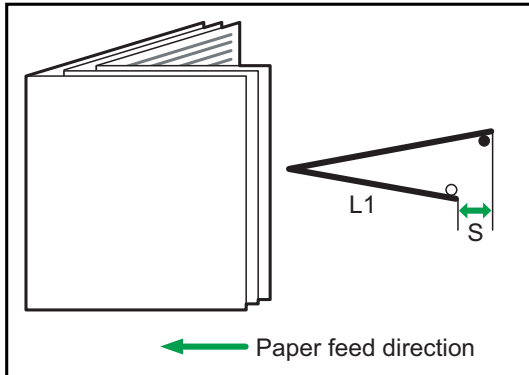

CWY007

Setting Items	Default Value	Max. Value	Min. Value	Step	Unit
A3 SEF	0.0	4.0	-4.0	0.2	mm
B4 JIS SEF					
A4 SEF					
B5 JIS SEF					
SRA3 SEF					
SRA4 SEF					
310 × 432mm SEF					
226 × 310mm SEF					
13 × 19 ¹ / ₅ SEF					
13 × 19 SEF					
13 × 18 SEF					
12 ³ / ₅ × 19 ¹ / ₅ SEF					
12 ³ / ₅ × 18 ¹ / ₂ SEF					
12 × 18 SEF					
11 × 17 SEF					
8 ¹ / ₂ × 14 SEF					
8 ¹ / ₂ × 11 SEF					
8K SEF					
Other Paper Sizes					

Adjustment Settings for Operators

0705 Letter Fold-out Position 1: 1 sheet Fold

Adjust the fold position of the bottom segment (S2) of letter foldout sheets (1 sheet fold) when using the fold unit.

Press [+] to increase and [-] to reduce (S2).

This setting will be applied if the single-sheet fold function is enabled.

The ○ mark indicates the leading edge (relative to the paper feed direction), and the ● mark indicates the trailing edge.

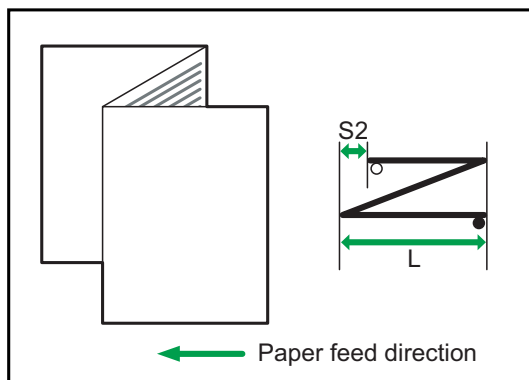

DWP563

Setting Items	Default Value	Max. Value	Min. Value	Step	Unit
A3 SEF B4 JIS SEF A4 SEF	0.0	4.0	-4.0	0.2	mm
B5 JIS SEF	0.0	3.0	-3.0	0.2	mm
12 × 18 SEF 11 × 17 SEF 8 ¹ / ₂ × 14 SEF 8 ¹ / ₂ × 11 SEF 8K SEF Other Paper Sizes	0.0	4.0	-4.0	0.2	mm

0706 Letter Fold-out Position 1: Multi-sheet Fold

Adjust the fold position of the bottom segment of letter foldout sheets (multi-sheet fold) when using the fold unit. This setting will be applied if the multi-sheet fold function is enabled.

Press [+] to increase and [-] to reduce (S2).

Adjustment Settings for Operators

The ○ mark indicates the leading edge (relative to the paper feed direction), and the ● mark indicates the trailing edge.

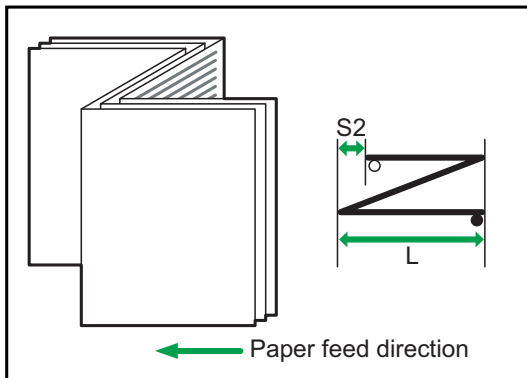

CWY008

Setting Items	Default Value	Max. Value	Min. Value	Step	Unit
B4 JIS SEF A4 SEF	0.0	4.0	-4.0	0.2	mm
B5 JIS SEF	0.0	3.0	-3.0	0.2	mm
8 ¹ / ₂ × 14 SEF 8 ¹ / ₂ × 11 SEF Other Paper Sizes	0.0	4.0	-4.0	0.2	mm

0707 Letter Fold-out Position 2: 1 sheet Fold

Adjust the overall fold size (L) of letter foldout sheets (1 sheet fold) when using the fold unit.

Press [+] to increase and [-] to reduce (L).

This setting will be applied if the single-sheet fold function is enabled.

The ○ mark indicates the leading edge (relative to the paper feed direction), and the ● mark indicates the trailing edge.

Adjustment Settings for Operators

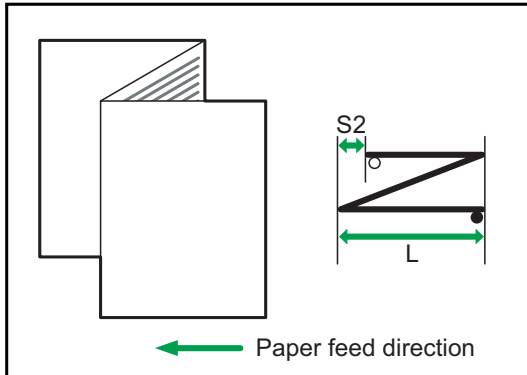

DWP563

Setting Items	Default Value	Max. Value	Min. Value	Step	Unit
A3 SEF B4 JIS SEF A4 SEF	0.0	4.0	-4.0	0.2	mm
B5 JIS SEF	0.0	3.0	-3.0	0.2	mm
12 × 18 SEF 11 × 17 SEF 8 ¹ / ₂ × 14 SEF 8 ¹ / ₂ × 11 SEF 8K SEF Other Paper Sizes	0.0	4.0	-4.0	0.2	mm

0708 Letter Fold-out Position 2: Multi-sheet Fold

Adjust the overall fold size of letter foldout sheets (multi-sheet fold) when using the fold unit. This setting will be applied if the multi-sheet fold function is enabled.

Press [+] to increase and [-] to reduce (L).

The ○ mark indicates the leading edge (relative to the paper feed direction), and the ● mark indicates the trailing edge.

Adjustment Settings for Operators

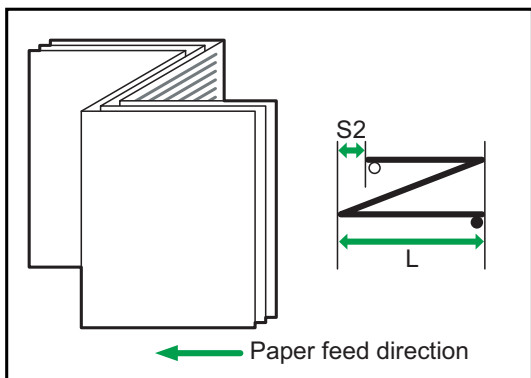

CWY008

Setting Items	Default Value	Max. Value	Min. Value	Step	Unit
B4 JIS SEF A4 SEF	0.0	4.0	-4.0	0.2	mm
B5 JIS SEF	0.0	3.0	-3.0	0.2	mm
8 ¹ / ₂ × 14 SEF 8 ¹ / ₂ × 11 SEF Other Paper Sizes	0.0	4.0	-4.0	0.2	mm

0709 Letter Fold-in Position 1: 1 sheet Fold

Adjust the fold position of the bottom segment (S) of letter fold-in sheets (1 sheet fold) when using the fold unit.

Press [+] to increase and [-] to reduce (S).

This setting will be applied if the single-sheet fold function is enabled.

The ○ mark indicates the leading edge (relative to the paper feed direction), and the ● mark indicates the trailing edge.

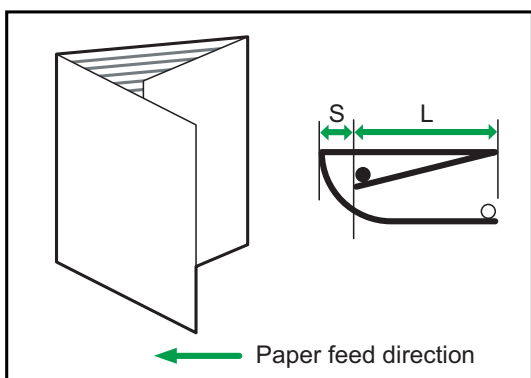

DWP564

Adjustment Settings for Operators

Setting Items	Default Value	Max. Value	Min. Value	Step	Unit
A3 SEF	0.0	4.0	-4.0	0.2	mm
B4 JIS SEF					
A4 SEF					
B5 JIS SEF					
12 × 18 SEF					
11 × 17 SEF					
8 ¹ / ₂ × 14 SEF					
8 ¹ / ₂ × 11 SEF					
8K SEF					
Other Paper Sizes					

0710 Letter Fold-in Position 1: Multi-sheet Fold

Adjust the fold position of the bottom segment of letter fold-in sheets (multi-sheet fold) when using the fold unit.

This setting will be applied if the multi-sheet fold function is enabled.

Press [+] to increase and [-] to reduce (S).

The ○ mark indicates the leading edge (relative to the paper feed direction), and the ● mark indicates the trailing edge.

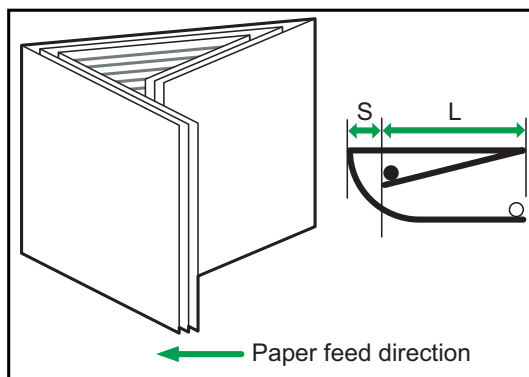

CWY009

Adjustment Settings for Operators

Setting Items	Default Value	Max. Value	Min. Value	Step	Unit
A3 SEF	0.0	4.0	-4.0	0.2	mm
B4 JIS SEF					
A4 SEF					
B5 JIS SEF					
12 × 18 SEF					
11 × 17 SEF					
8 ¹ / ₂ × 14 SEF					
8 ¹ / ₂ × 11 SEF					
8K SEF					
Other Paper Sizes					

0711 Letter Fold-in Position 2: 1 sheet Fold

Adjust the fold size of letter fold-in sheets (1 sheet fold) when using the fold unit.

Press [+] to increase and [-] to reduce (LS).

This setting will be applied if the single-sheet fold function is enabled.

The ○ mark indicates the leading edge (relative to the paper feed direction), and the ● mark indicates the trailing edge.

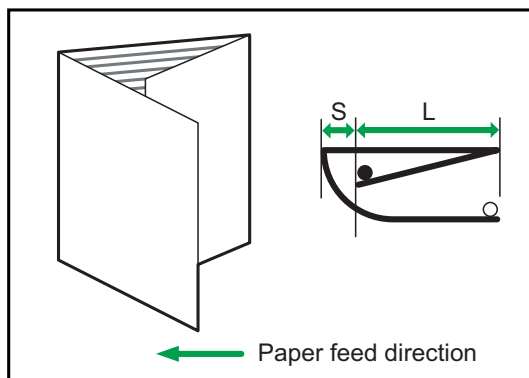

DWP564

Adjustment Settings for Operators

Setting Items	Default Value	Max. Value	Min. Value	Step	Unit
A3 SEF	0.0	4.0	-4.0	0.2	mm
B4 JIS SEF					
A4 SEF					
B5 JIS SEF					
12 × 18 SEF					
11 × 17 SEF					
8 ¹ / ₂ × 14 SEF					
8 ¹ / ₂ × 11 SEF					
8K SEF					
Other Paper Sizes					

0712 Letter Fold-in Position 2: Multi-sheet Fold

Adjust the fold size when Inside 3 Folding is executed (Overlap Folding) when using the fold unit. Press [+] to increase and [-] to reduce (L).

The ○ mark indicates the leading edge (relative to the paper feed direction), and the ● mark indicates the trailing edge.

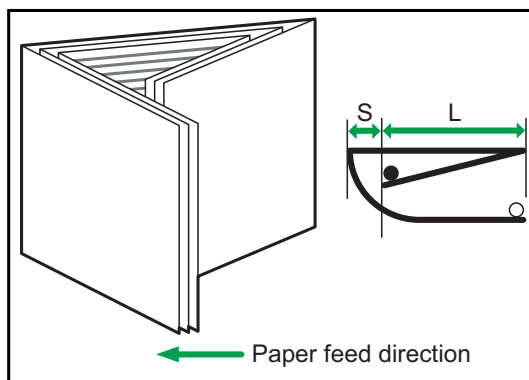

CWY009

Adjustment Settings for Operators

Setting Items	Default Value	Max. Value	Min. Value	Step	Unit
A3 SEF B4 JIS SEF A4 SEF B5 JIS SEF 12 × 18 SEF 11 × 17 SEF 8 ¹ / ₂ × 14 SEF	0.0	4.0	-4.0	0.2	mm
8 ¹ / ₂ × 11 SEF	0.0	4.0	0.0	0.2	mm
8K SEF Other Paper Sizes	0.0	4.0	-4.0	0.2	mm

0713 Double Parallel Fold Position 1

Adjust the fold position (S1) of the bottom segment 1 of double parallel-folded sheets when using the fold unit.

Press [+] to increase and [-] to reduce (S1).

The ○ mark indicates the leading edge (relative to the paper feed direction), and the ● mark indicates the trailing edge. The illustration below shows a gatefold sheet partially opened in the half-folded state.

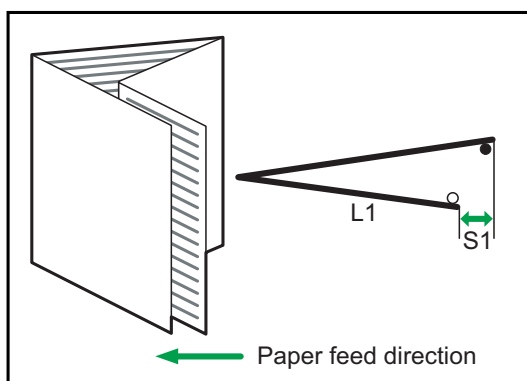

DWP565

Adjustment Settings for Operators

Setting Items	Default Value	Max. Value	Min. Value	Step	Unit
A3 SEF	0.0	4.0	-4.0	0.2	mm
B4 JIS SEF					
A4 SEF					
B5 JIS SEF					
12 × 18 SEF					
11 × 17 SEF					
8 ¹ / ₂ × 14 SEF					
8 ¹ / ₂ × 11 SEF					
8K SEF					
Other Paper Sizes					

0714 Double Parallel Fold Position 2

Adjust the fold position (S2) of the bottom segment 2 of double parallel-folded sheets when using the fold unit.

Press [+] to increase and [-] to reduce (S2).

The ○ mark indicates the leading edge (relative to the paper feed direction), and the ● mark indicates the trailing edge.

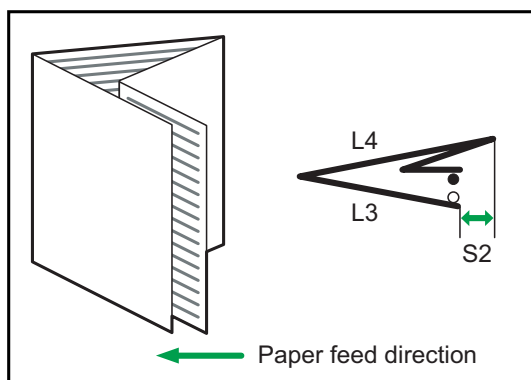

DWP566

Adjustment Settings for Operators

Setting Items	Default Value	Max. Value	Min. Value	Step	Unit
A3 SEF	0.0	4.0	-4.0	0.2	mm
B4 JIS SEF					
A4 SEF					
B5 JIS SEF					
12 × 18 SEF					
11 × 17 SEF					
8 ¹ / ₂ × 14 SEF					
8 ¹ / ₂ × 11 SEF					
8K SEF					
Other Paper Sizes					

0715 Gate Fold Position 1

Adjust the fold position (S1) of the bottom segment 1 of gatefold sheets when using the fold unit.

Press [+] to increase and [-] to reduce (S1).

The ○ mark indicates the leading edge (relative to the paper feed direction), and the ● mark indicates the trailing edge. The illustration below shows a gatefold sheet partially opened in the half-folded state.

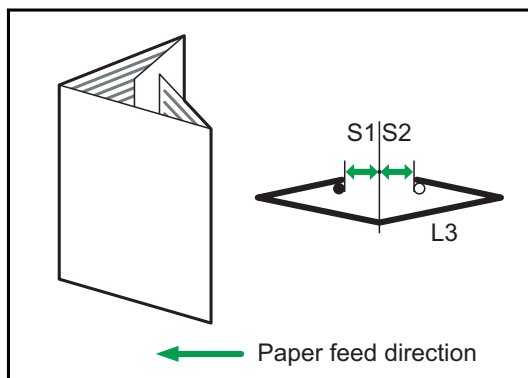

DWP567

Adjustment Settings for Operators

Setting Items	Default Value	Max. Value	Min. Value	Step	Unit
A3 SEF	0.0	4.0	-4.0	0.2	mm
B4 JIS SEF					
A4 SEF					
B5 JIS SEF					
11 × 17 SEF					
8 ¹ / ₂ × 14 SEF					
8 ¹ / ₂ × 11 SEF					
8K SEF					
Other Paper Sizes					

0716 Gate Fold Position 2

Adjust the fold position (S2) of the bottom segment 2 of gatefold sheets when using the fold unit.

Press [+] to increase and [-] to reduce (S2).

The ○ mark indicates the leading edge (relative to the paper feed direction), and the ● mark indicates the trailing edge. The illustration below shows a gatefold sheet partially opened in the half-folded state.

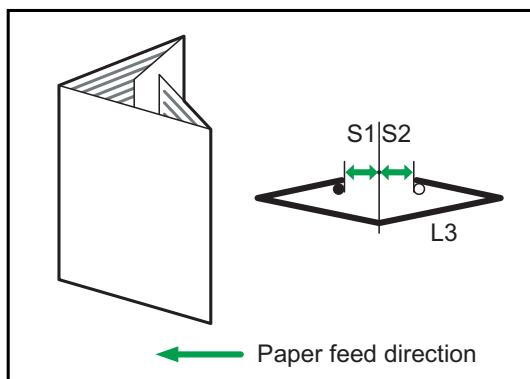

DWP567

Adjustment Settings for Operators

Setting Items	Default Value	Max. Value	Min. Value	Step	Unit
A3 SEF	0.0	4.0	-4.0	0.2	mm
B4 JIS SEF					
A4 SEF					
B5 JIS SEF					
11 × 17 SEF					
8 ¹ / ₂ × 14 SEF					
8 ¹ / ₂ × 11 SEF					
8K SEF					
Other Paper Sizes					

0717 Gate Fold Position 3

Adjust the fold position (S3) of the bottom segment 3 of gatefold sheets when using the fold unit.

Press [+] to increase and [-] to reduce (S3).

The ○ mark indicates the leading edge (relative to the paper feed direction), and the ● mark indicates the trailing edge.

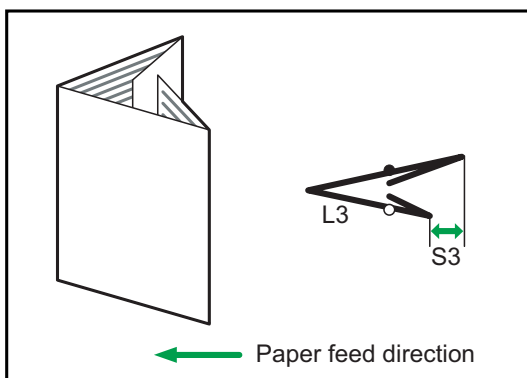

DWP568

Adjustment Settings for Operators

Setting Items	Default Value	Max. Value	Min. Value	Step	Unit
A3 SEF	0.0	4.0	-4.0	0.2	mm
B4 JIS SEF					
A4 SEF					
B5 JIS SEF					
12 × 18 SEF					
11 × 17 SEF					
8 ¹ / ₂ × 14 SEF					
8 ¹ / ₂ × 11 SEF					
8K SEF					
Other Paper Sizes					

Finishing: Perfect Binder

0801 Perf Bind Cvr Sht Posit: Across Feed

Adjust the vertical alignment of the cover sheet position when performing perfect binding. When you bind the copies with the perfect binder, make this adjustment if the center of the book block's spine and the center of the cover sheet are misaligned vertically.

Press [+] or [-] to move the image backward or forward.

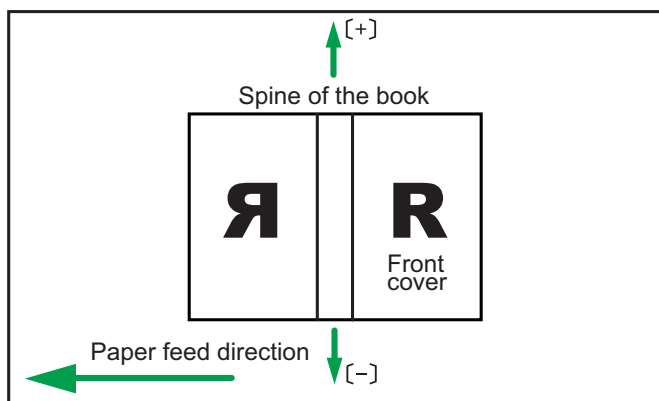

CWY011

Setting Items	Default Value	Max. Value	Min. Value	Step	Unit
Set	0.0	5.0	-5.0	0.1	mm

Adjustment Settings for Operators

0802 Perf Bind Cvr Sht Posit: With Feed

Adjust the horizontal alignment of the cover sheet position when performing perfect binding. When you bind the copies with the perfect binder, make this adjustment if the center of the book block's spine and the center of the cover sheet are misaligned horizontally. Press [+] or [-] to move the image feed direction or reverse feed direction.

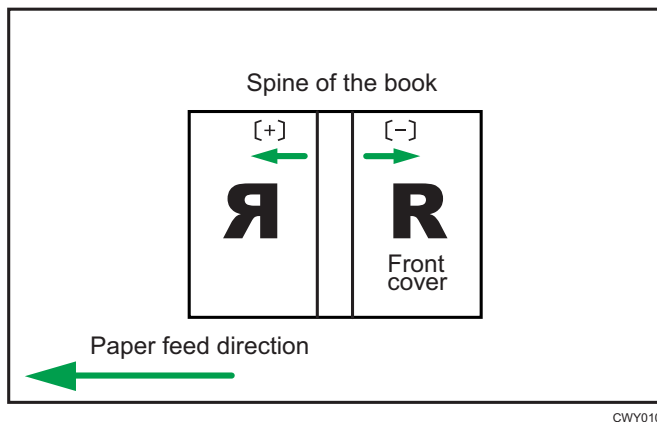

Setting Items	Default Value	Max. Value	Min. Value	Step	Unit
Set	0.0	5.0	-5.0	0.1	mm

0803 Perfect Binding Finishing Angle

Square the top, bottom, and outside edges when trimming a deck of paper. Make this adjustment if the three edges of the deck of paper cut by the perfect binder are not square. Enter the distance from the square part at each edge.

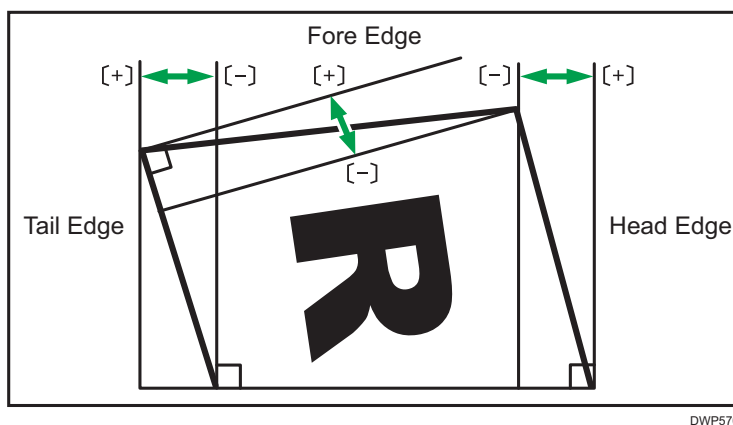

CIP Training Pro C9200 series

Adjustment Settings for Operators

Setting Items	Default Value	Max. Value	Min. Value	Step	Unit
Tail Edge	0.0	10.0	-10.0	0.1	mm
Head Edge					
Fore Edge					

0804 Applying Binding Glue

Adjust the amount of binding glue for perfect binding. If there is not enough glue, some pages may not stick.

If there is too much glue, the glue may be squeezed out of the binding and stick the pages together making it difficult to open the booklet.

Setting Items	Default Value	Max. Value	Min. Value	Step	Unit
Set	0.00	0.30	-0.30	0.05	mm

Finishing: Stacker

0901 Ppr Align in Stack Tray: Acr Feed 1

Adjust the alignment width in Main Jogger^{*1} when output sheets are stacked on the stacker.

Use the function to reduce the dispersion of paper orientation at a right angle due to paper size, thickness, curl and so on.

Press [+] or [-] to increase or decrease the width.

CIP Training Pro C9200 series

Adjustment Settings for Operators

Setting Items	Default Value	Max. Value	Min. Value	Step	Unit
A3 SEF	0.0	1.0	-1.0	0.1	mm
B4 JIS SEF					
A4 LEF					
A4 SEF					
B5 JIS LEF					
B5 JIS SEF					
A5 LEF					
A5 SEF					
11 × 17 SEF					
8 ¹ / ₂ × 14 SEF					
8 ¹ / ₂ × 11 LEF					
8 ¹ / ₂ × 11 SEF					
5 ¹ / ₂ × 8 ¹ / ₂ LEF					
5 ¹ / ₂ × 8 ¹ / ₂ SEF					
Other Paper Sizes					

*1 A guide for aligning output sheets when they are ejected and delivered to the stacker. The guide is located inside the stacker.

0902 Ppr Align in Stack Tray: Acr Feed 2

Adjust the alignment width in Sub Jogger*¹ when output sheets are stacked on the stacker. Use the function to reduce the dispersion of paper orientation at a right angle due to paper size, thickness, curl and so on.

Press [+] or [-] to increase or decrease the width.

Setting Items	Default Value	Max. Value	Min. Value	Step	Unit
A3 SEF	0.0	1.0	-1.0	0.1	mm
B4 JIS SEF					
11 × 17 SEF					
8 ¹ / ₂ × 14 SEF					
Other Paper Sizes					

CIP Training Pro C9200 series

Adjustment Settings for Operators

*1 A guide for aligning output sheets when they are ejected and delivered to the stacker. The guide is located inside the stacker.

0903 Paper Alignment in Stacker Tray: With Feed

Adjust the alignment position of the Tip Stopper when output sheets are ejected on the Stacker. Use the function to reduce the dispersion of paper orientation in the feeding direction due to paper size, thickness, curl and so on.

Press [+] or [-] to decrease or increase the amount of movement.

Setting Items	Default Value	Max. Value	Min. Value	Step	Unit
A3 SEF	0.0	1.0	-1.0	0.1	mm
B4 JIS SEF					
A4 LEF					
A4 SEF					
B5 JIS LEF					
B5 JIS SEF					
A5 LEF					
A5 SEF					
11 × 17 SEF					
8 ¹ / ₂ × 14 SEF					
8 ¹ / ₂ × 11 LEF					
8 ¹ / ₂ × 11 SEF					
5 ¹ / ₂ × 8 ¹ / ₂ LEF					
5 ¹ / ₂ × 8 ¹ / ₂ SEF					
Other Paper Sizes					

0904 Ppr Align in 2nd Stack Tray: Acr Feed 1

Adjust the alignment width in Main Jogger*1 when output sheets are stacked on the 2nd stacker.

Use the function to reduce the dispersion of paper orientation at a right angle due to paper size, thickness, curl and so on.

Press [+] or [-] to increase or decrease the width.

CIP Training Pro C9200 series

Adjustment Settings for Operators

Setting Items	Default Value	Max. Value	Min. Value	Step	Unit
A3 SEF	0.0	1.0	-1.0	0.1	mm
B4 JIS SEF					
A4 LEF					
A4 SEF					
B5 JIS LEF					
B5 JIS SEF					
A5 LEF					
A5 SEF					
11 × 17 SEF					
8 ¹ / ₂ × 14 SEF					
8 ¹ / ₂ × 11 LEF					
8 ¹ / ₂ × 11 SEF					
5 ¹ / ₂ × 8 ¹ / ₂ LEF					
5 ¹ / ₂ × 8 ¹ / ₂ SEF					
Other Paper Sizes					

*1 A guide for aligning output sheets when they are ejected and delivered to the stacker. The guide is located inside the stacker.

0905 Ppr Align in 2nd Stack Tray: Acr Feed 2

Adjust the alignment width in Sub Jogger^{*1} when output sheets are stacked on the 2nd stacker. Use the function to reduce the dispersion of paper orientation at a right angle due to paper size, thickness, curl and so on.

Press [+] or [-] to increase or decrease the width.

Setting Items	Default Value	Max. Value	Min. Value	Step	Unit
A3 SEF	0.0	1.0	-1.0	0.1	mm
B4 JIS SEF					
11 × 17 SEF					
8 ¹ / ₂ × 14 SEF					
Other Paper Sizes					

CIP Training Pro C9200 series

Adjustment Settings for Operators

*1 A guide for aligning output sheets when they are ejected and delivered to the stacker. The guide is located inside the stacker.

0906 Ppr Align in 2nd Stack Tray: With Feed

Adjust the alignment position of the Tip Stopper when output sheets are ejected on the 2nd stacker. Use the function to reduce the dispersion of paper orientation in the feeding direction due to paper size, thickness, curl and so on.

Press [+] or [-] to decrease or increase the amount of movement.

Setting Items	Default Value	Max. Value	Min. Value	Step	Unit
A3 SEF	0.0	1.0	-1.0	0.1	mm
B4 JIS SEF					
A4 LEF					
A4 SEF					
B5 JIS LEF					
B5 JIS SEF					
A5 LEF					
A5 SEF					
11 × 17 SEF					
8 ¹ / ₂ × 14 SEF					
8 ¹ / ₂ × 11 LEF					
8 ¹ / ₂ × 11 SEF					
5 ¹ / ₂ × 8 ¹ / ₂ LEF					
5 ¹ / ₂ × 8 ¹ / ₂ SEF					
Other Paper Sizes					

0907 Maximum Stack Quantity in Stacker Tray

Specify the maximum number of sheets that can be stacked on the stacker tray. The setting applies to both the 1st and 2nd stackers.

The maximum number of sheets you can set differs depending on the size, thickness, and paper curl. Set the maximum number by specifying a ratio based on the number of sheets. Select [Large Size] when using paper whose vertical and horizontal lengths are 210 mm or longer whose area is 8¹/₂ × 11 or wider. Select [Small Size] when using other size paper.

CIP Training Pro C9200 series

Adjustment Settings for Operators

Major paper sizes that apply to each item are as follows:

- Large Size: A3 or larger (up to 13 × 19^{1/2}), B4 JIS, A4, 11 × 17, 8^{1/2} × 14, 8^{1/2} × 11
- Small Size: B5 JIS, A5, 5^{1/2} × 8^{1/2}

If the unit detects that the number of sheets reaches the set upper limit, a warning message

Setting Items	Values	Default Value
Large Size	100% 75% 50% 25%	100%
Small Size	100% 75% 50% 25%	50%

RICOH
imagine. change.