

CIP Training

Pro 8300 series

Adjustment Settings for Operators

RICOH
imagine. change.

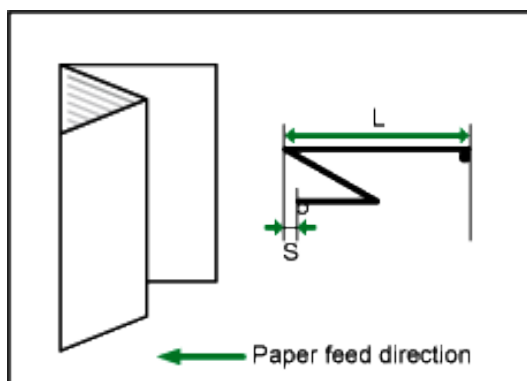
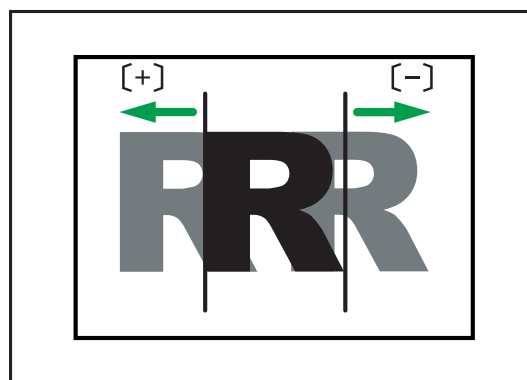

D RIC606

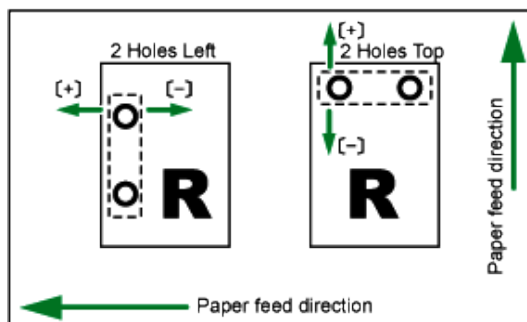



CV K006

Adjustment Settings for Operators

How to Use the [Adjustment Settings for Operators] Screen

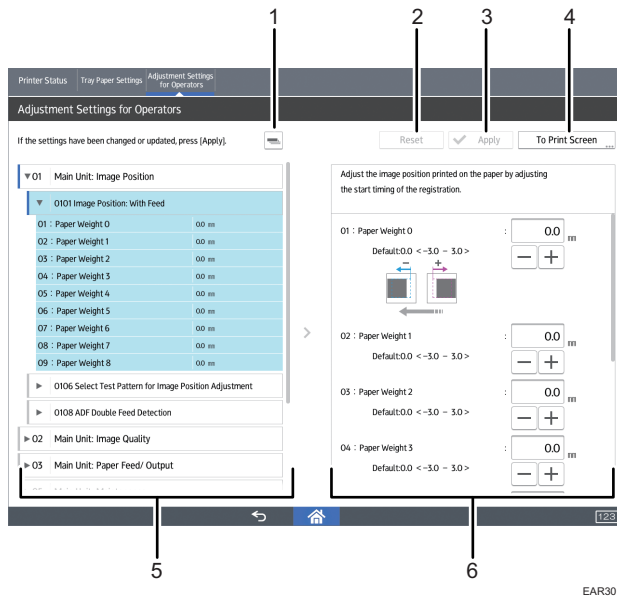
This section explains how to use the Adjustment Settings for Operators.



1.  Press this key to collapse the hierarchical display of the adjustment items, and display only the group names of those items.
2. [Reset] Press this key to reset the settings/modifications being currently configured. The settings/modifications cannot be reset after you press [Apply].
3. [Apply] Press this key to apply the settings/modifications.
4. [To Print Screen] Press this key to display the print screen. You can use this screen to view the changes you have made.
5. Adjustment items Adjustment items are displayed in this area. When you select an item, its configuration screen will then open.
6. Configuration screen Configure or modify the settings of the adjustment item that you have selected.

Note

- All items in Adjustment Settings for Operators appear regardless of which of the machine's optional components are installed. If you change the settings of options that are not installed, the changes will have no effect.

Adjustment Settings for Operators

Accessing the Adjustment Settings for Operators

1. Press [Adjustment Settings for Operators] on the Home screen.
2. Select and change adjustment settings.
The method for changing the selected adjustment setting depends on the setting that you want to change. For details, see "Features of the Displayed Items and Setting Operations".
3. Press [Apply].
4. Press [Home]  at the bottom of the screen in the center.

Features of the Displayed Items and Setting Operations

The following operations are available for each adjustment item:

- Value setting
- Item setting
- Executing
- Display only

Value setting

Press [+] to increase the value, or [-] to decrease or use the numeric keypad to enter the value.

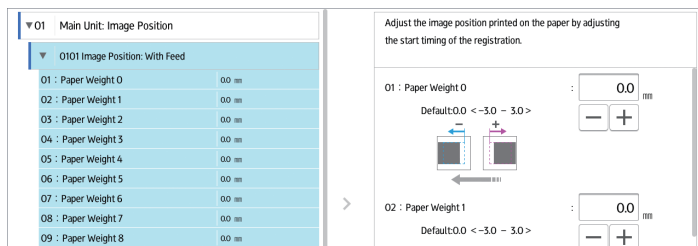

Adjustment Settings for Operators

For some settings, move the slider right or left to increase or decrease the setting value.

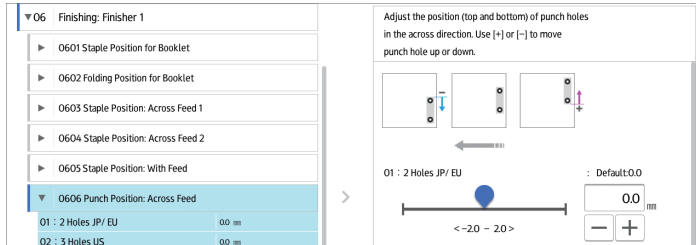

A numeric keypad appears to the left when you press the input box. Use the keypad to enter a value.

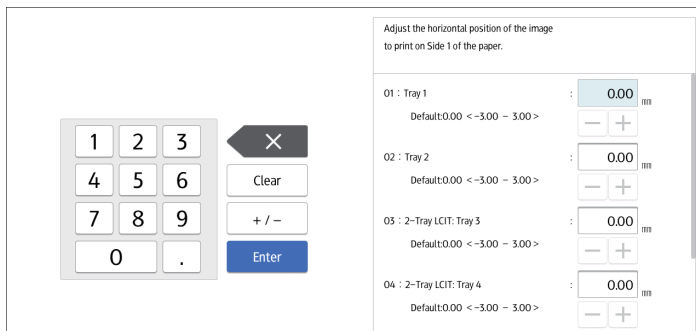

- [x]: Press to delete the entered value character by character.
- [Clear]: Clear the entered value.
- [+/-]: Change the sign of the entered value from + (positive) to - (negative) and vice versa.
- [Enter]: Confirm the entered value.

For some items, you can select a value from the pull-down list that appears when you press the input box. Select a value from the list.

Adjustment Settings for Operators

Item setting

Select the item you require.

▶ 01 Main Unit: Image Position	
▶ 02 Main Unit: Image Quality	
▼ 03 Main Unit: Paper Feed/ Output	
▼ 0301 Double Feed Detection	
01 : Tray 1	On
02 : Tray 2	On
03 : Tray 3	On
07 : Tray 7	On
08 : Tray T1	On
09 : Tray T2	On
▶ 0302 When Double Feed is Detected	
▶ 0304 Skew Detection	
▶ 0310 Correct Output Paper Curl	
▶ 05 Main Unit: Maintenance	

Set whether to detect double feed.	
01 : Tray 1	: Default *
<input type="text" value="Off"/>	<input type="button" value="On *"/>
02 : Tray 2	: Default *
<input type="text" value="Off"/>	<input type="button" value="On *"/>
03 : Tray 3	: Default *
<input type="text" value="Off"/>	<input type="button" value="On *"/>
07 : Tray 7	: Default *
<input type="text" value="Off"/>	<input type="button" value="On *"/>
08 : Tray T1	: Default *
<input type="text" value="Off"/>	<input type="button" value="On *"/>
09 : Tray T2	: Default *
<input type="text" value="Off"/>	<input type="button" value="On *"/>

Executing

Press [Execute] to perform a selected function.

▶ 01 Main Unit: Image Position	
▼ 02 Main Unit: Image Quality	
▼ 0202 Execute Image Quality Adjustment	
01 : Adjust Image Density	
▶ 0208 Avoid Paper Transfer Shock Jitter: Feed Interval	
▶ 03 Main Unit: Paper Feed/ Output	
▶ 05 Main Unit: Maintenance	

Execute the following adjustment manually.	
01 : Adjust Image Density :	<input type="button" value="Execute"/>

Display Only

You can check the setting of the selected item.

▶ 01 Main Unit: Image Position	
▶ 02 Main Unit: Image Quality	
▶ 03 Main Unit: Paper Feed/ Output	
▼ 05 Main Unit: Maintenance	
▶ 0502 Execute Photoconductor Refreshing	
▼ 0517 Temperature / Humidity Inside	
01 : Temperature	0 deg
02 : Humidity	0 %RH

Display temperature and humidity inside the machine.	

Adjustment Settings for Operators

Printing with Adjusted Settings

To print with the settings you have adjusted, be sure to select the paper tray and paper size to which the settings apply.

- Settings adjustable for each paper tray
- Settings adjustable for each paper size

Settings adjustable for each paper tray

- These are settings adjustable for each paper tray.
- Print jobs are processed with the adjusted settings when printing from a tray with the applied settings.

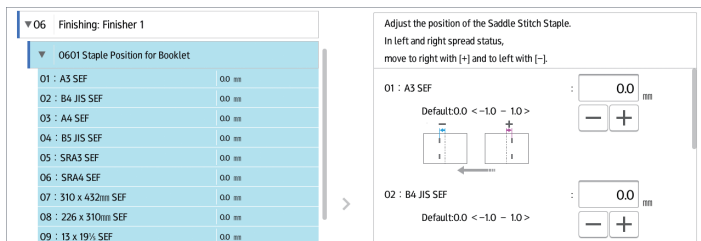

Settings adjustable for each paper size

- These are settings adjustable for each paper size.
- Print jobs are processed with the adjusted settings when printing with a paper size that has the applied settings.

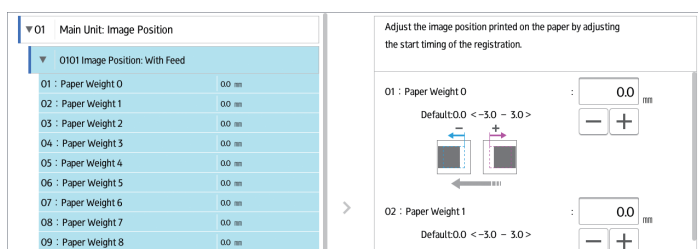

Note

- For details about selecting the paper tray and paper size for printing, see the manuals for the related functions.

Adjustment Settings for Operators

Menu Items and Function

All items in Adjustment Settings for Operators appear regardless of which of the machine's optional components are installed. If you change the settings of options that are not installed, the changes will have no effect.

01: Machine: Image Position

0101 Image Position: With Feed

Adjust the horizontal position of the print image.
You cannot individually adjust the image position on sides 1 and 2.

Side 1

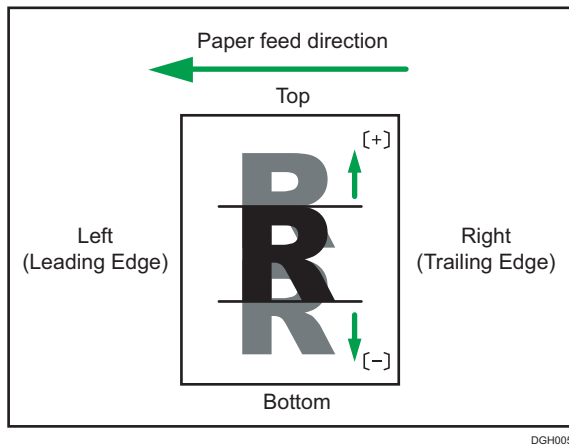

DGH005

Press [+] to shift the image to the right (trailing edge).

Press [-] to shift the image the left (leading edge).

Side 2

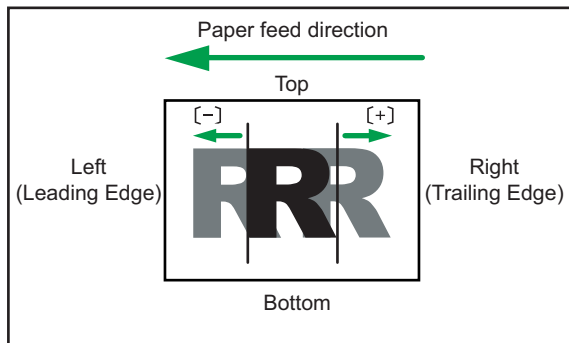

CWY006

Press [+] to shift the image to the left (trailing edge).

Press [-] to shift the image to the right (leading edge).

Adjustment Settings for Operators

Setting Items	Default Value	Max. Value	Min. Value	Step	Unit
Paper Weight 0	0.0	3.0	-3.0	0.1	mm
Paper Weight 1					
Paper Weight 2					
Paper Weight 3					
Paper Weight 4					
Paper Weight 5					
Paper Weight 6					
Paper Weight 7					
Paper Weight 8					

↓ Note

- If sheets are delivered face down, turn them over horizontally and check the image position.
- If the leading-edge margin on Side 1 of the paper is too narrow, paper jams may occur.
- If the trailing-edge margin on Side 1 of the paper is too narrow, paper jams may occur when printing on the back side of paper during duplex printing.

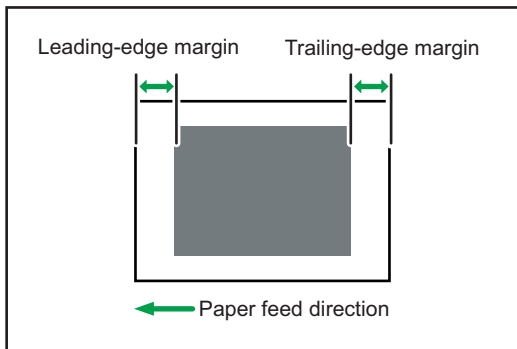

CWY015

- This setting is not effective for paper fed from paper trays with custom paper presets. For such paper, the value specified in [Image Position: Side1] in [Advanced Settings] takes precedence.

Adjustment Settings for Operators

0106 Select Test Pattern for Image Position Adjustment

Select the test image for adjusting the image position.

If [Copy Image] is selected, the image scanned using the Auto Document Feeder (ADF) or exposure glass is printed.

If [Frame Image] is selected, stripe test patterns are printed.

Setting Items	Values	Default Value
Test Pattern	Copy Image Frame Image	Copy Image

0108 ADF Double Feed Detection

Specify whether or not to detect multiple feeding of originals loaded in the Auto Document Feeder (ADF).

If [On] is selected, the machine stops printing and displays a message reporting a paper jam when it detects multiple feeding. The machine may erroneously detect double feeding when you use creased, scratched or torn originals, originals with holes, perforated originals, or originals with sticky notes or tape affixed. In such a case, select [Off] to prevent erroneous detection.

Setting Items	Values	Default Value
Setting	[On] [Off]	[On]

Adjustment Settings for Operators

Machine: Image Quality

0202 Execute Image Quality Adjustment

Execute image density control manually.

The machine adjusts the image density. This operation takes about 30 seconds during which a message appears on the control panel. Do not pull out the drawer while the message is being displayed.

If the density does not change after applying this function several times, contact your service representative.

Setting Items	Values
Adjust Image Density	Press [OK] to apply the setting.

Note

- The machine executes automatic image density adjustment after a set interval or after printing a specified number of sheets. However, you can also manually initiate automatic image density adjustment whenever you want.

0208 Avoid Paper Transfer Shock Jitter: Feed Interval

Specify whether or not to enable the mode to reduce the jitter*1 produced when paper enters the paper transfer roller.

If "1" is selected, the machine adjusts the interval between sheets to reduce jitter.

However, the throughput may be reduced when you use paper larger than A4 or 8 1/2 × 14.

If this happens, turn this setting off to improve the throughput.

Setting Items	Default Value	Max. Value	Min. Value	Step	Unit
Setting	0	1	0	1	–

*1 The jitter occurs when the leading or trailing edge of paper that passes through the paper transfer unit is transmitted to the drum unit via the intermediate transfer belt, causing banding.

Note

- Jitter does not occur with A4 or smaller paper.
- This setting is not effective for paper fed from paper trays with custom paper presets. For such paper, the value specified in [Avoid Paper Transfer Shock Jitter: Feed Interval] in "Advanced Settings" takes precedence.

Adjustment Settings for Operators

Machine: Paper Feed/ Output

0301 Double Feed Detection

Specify whether or not to detect double feeding of paper.

If [On] is selected, the machine stops when it detects paper double feeding, so as to prevent mixing of unprinted paper.

The machine may not correctly detect double feeding when using special paper (two-ply paper such as release paper). In such a case, select [Off].

Setting Items	Values	Default Value
Tray 1	Off	On
Tray 2	On	
Tray 3		
Tray 4		
Tray 5		
Tray 6		
Tray A		
Tray T1		
Tray T2		
Tray T3		
Tray T4		

↓ Note

- This setting is not effective for paper fed from paper trays with custom paper presets. For such paper, the value specified in [Double Feed Detection] in "Advanced Settings" takes precedence.

0302 When Double Feed is Detected

Specify how the machine behaves when it detects a double feed.

If [Suspended] is selected, the machine, on detecting a double feed, stops printing and displays a paper misfeed message.

If [Suspended After Paper Diversion] is selected, the machine stops printing if a double feed is detected, then delivers the sheets to the paper trap inside the machine at the bottom left, and displays a paper misfeed message.

This setting is enabled only if [Double Feed Detection] is set to [On].

Adjustment Settings for Operators

Setting Items	Values	Default Value
Setting	Suspended Suspended After Paper Diversion	Suspended After Paper Diversion

0304 Skew Detection

Specify whether or not to detect paper skew.

If the machine detects a paper skew when [On] is selected, the machine will stop printing and display a message reporting a paper jam.

The machine may erroneously detect paper skew when using dark paper or paper printed to its edges. In such a case, select [Off].

Setting Items	Values	Default Value
Tray 1	Off	On
Tray 2	On	
Tray 3		
Tray 4		
Tray 5		
Tray 6		
Tray A		
2 Sided		
Tray T1		
Tray T2		
Tray T3		
Tray T4		

Note

- This setting is not effective for paper fed from paper trays with custom paper presets. For such paper, the value specified in [Skew Detection] in "Advanced Settings" takes precedence.

Adjustment Settings for Operators

0310 Correct Output Paper Curl

Specify the method for straightening curled sheets.

Select the method according to the direction and degree of curl.

If the paper is curled face up, select "U Curl Correction Level". If it is curled face down, select "Π Curl Correction Level". Depending on how much the paper is curled, specify the degree of correction by selecting "Weak" or "Strong".

Setting Items	Values	Default Value
Tray 1	U Curl Correction Level: Off	U Curl Correction Level: Off
Tray 2	U Curl Correction Level: Small	
Tray 3	U Curl Correction Level: Large	
Tray 4	Π Curl Correction Level: Off	
Tray 5	Π Curl Correction Level: Small	
Tray 6	Π Curl Correction Level: Large	
Tray A		
Tray T1		
Tray T2		
Tray T3		
Tray T4		

Main Unit: Maintenance

0502 Execute Photoconductor Refreshing

Remove dust on the drum surface.

This operation takes about 4 minutes. Do not open the front covers during the operation.

Setting Items	Values
Photoconductor Refreshing	Press [OK] to apply the setting(s).

Adjustment Settings for Operators

0517 Temperature / Humidity Inside

Display the internal temperature and humidity.

If your service representative requests it, report this information.

Setting Items	Values
Temperature	Value display only.
Humidity	

0518 Temperature / Humidity Outside

Display the external temperature and humidity.

If your service representative requests it, report this information.

Setting Items	Values
Temperature	Value display only.
Humidity	

0519 Display Banner for Conditions Outside Optimal Range

Specify whether or not to display the banner to indicate conditions outside the recommended operating environment.

Specify whether or not to display the banner when using the machine in conditions outside the recommended operating environment.

Setting Items	Values	Default Value
High Temperature/Humidity	Off	On
Low Temperature/Humidity	On	

0522 Execute Charger Cleaning

Clean the charge unit.

If the printed copies have vertical creases, clean the charge unit. This may reduce the problem.

Do not open any covers during the operation.

Setting Items	Values
Charger Cleaning	Press [OK].

Adjustment Settings for Operators

0523 Switch Print Screen

Set the function displayed when pressing [To Print Screen].

Setting Items	Values	Default Value
Setting	Copier Printer	Copier

Finishing: Finisher

0601 Staple Position: Across Feed 1

Adjust the vertical position of the staple (applied at an edge) when using Finisher SR5120.

Press [+] to move the stapling position left or [-] to move it right on the open booklet.

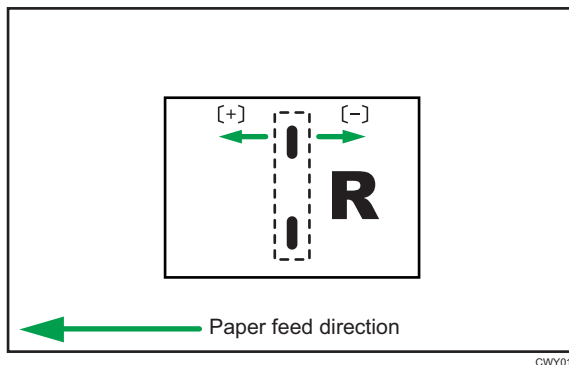

Adjustment Settings for Operators

Setting Items	Default Value	Max. Value	Min. Value	Step	Unit
A3 SEF	0.0	1.0	-1.0	0.1	mm
B4 JIS SEF					
A4 SEF					
B5 JIS SEF					
SRA3 SEF					
SRA4 SEF					
310 × 432mm SEF					
226 × 310mm SEF					
13 × 19 ¹ / ₅ SEF					
13 × 19 SEF					
13 × 18 SEF					
12 ³ / ₅ × 19 ¹ / ₅ SEF					
12 ³ / ₅ × 18 ¹ / ₂ SEF					
12 × 18 SEF					
11 × 17 SEF					
8 ¹ / ₂ × 14 SEF					
8 ¹ / ₂ × 13 ² / ₅ SEF					
8 ¹ / ₂ × 13 ¹ / ₂ SEF					
8 ¹ / ₂ × 11 SEF					
Other Paper Sizes					

0602 Folding Position for Booklet

Adjust the horizontal position of the folding when using Booklet Finisher SR5120. Press [+] to move the position left or press [-] to move it right on the open booklet.

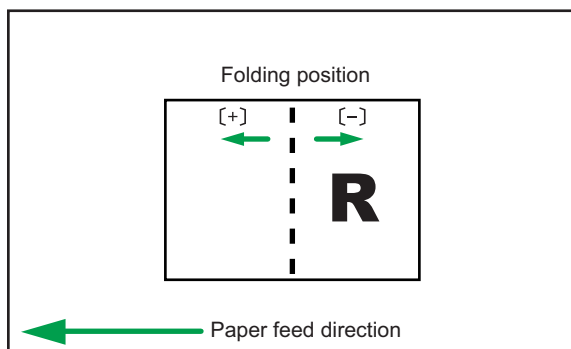

Adjustment Settings for Operators

Setting Items	Default Value	Max. Value	Min. Value	Step	Unit
A3 SEF	0.0	1.0	-1.0	0.1	mm
B4 JIS SEF					
A4 SEF					
B5 JIS SEF					
SRA3 SEF					
SRA4 SEF					
310 × 432mm SEF					
226 × 310mm SEF					
13 × 19 ¹ / ₅ SEF					
13 × 19 SEF					
13 × 18 SEF					
12 ³ / ₅ × 19 ¹ / ₅ SEF					
12 ³ / ₅ × 18 ¹ / ₂ SEF					
12 × 18 SEF					
11 × 17 SEF					
8 ¹ / ₂ × 14 SEF					
8 ¹ / ₂ × 13 ² / ₅ SEF					
8 ¹ / ₂ × 13 ¹ / ₂ SEF					
8 ¹ / ₂ × 11 SEF					
Other Paper Sizes					

0603 Staple Position: Across Feed 1

Adjust the vertical position of the staple (applied at an edge) when using Finisher SR5110 or Booklet Finisher SR5120.

Press [+] to move the stapling position away from the side edge of the sheet or [-] to move it toward the edge.

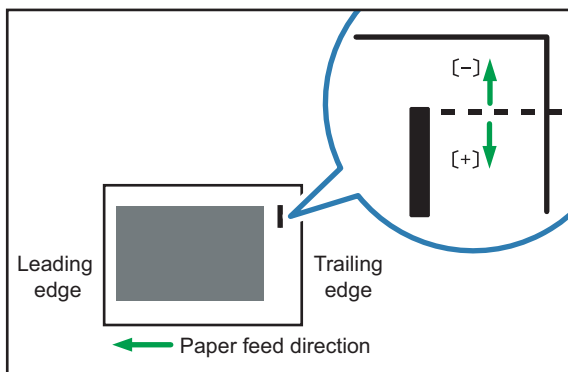

Adjustment Settings for Operators

Setting Items	Default Value	Max. Value	Min. Value	Step	Unit
A3 SEF	0.0	2.0	-2.0	0.1	mm
B4 JIS SEF					
A4 LEF					
A4 SEF					
B5 JIS LEF					
B5 JIS SEF					
11 × 17 SEF					
8 ¹ / ₂ × 14 SEF					
8 ¹ / ₂ × 13 ² / ₅ SEF					
8 ¹ / ₂ × 13 ¹ / ₂ SEF					
8 ¹ / ₂ × 11 LEF					
8 ¹ / ₂ × 11 SEF					
8K SEF					
16K LEF					
16K SEF					
Other Paper Sizes					

0604 Staple Position: Across Feed 2

Adjust the vertical distance (up and down) between the staples (dual) when using Finisher SR5110 or Booklet Finisher SR5120.

Press [+] to move the two stapling positions away from the center and each other or [-] to move it toward each other.

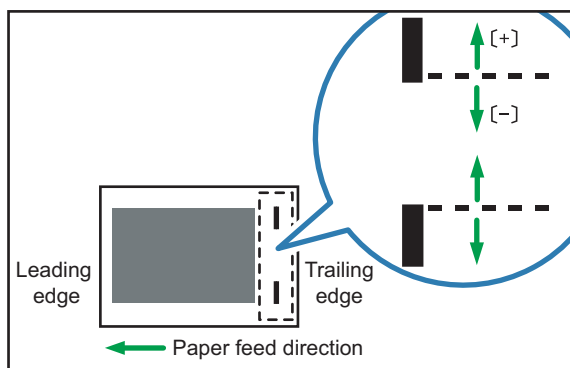

Adjustment Settings for Operators

Setting Items	Default Value	Max. Value	Min. Value	Step	Unit
A3 SEF	0.0	115	-14.5	0.5	mm
B4 JIS SEF		75			
A4 LEF		115			
A4 SEF		28			
B5 JIS LEF		75			
B5 JIS SEF		0			
11 × 17 SEF		98			
8 ¹ / ₂ × 14 SEF		34			
8 ¹ / ₂ × 13 ² / ₅ SEF					
8 ¹ / ₂ × 13 ¹ / ₂ SEF					
8 ¹ / ₂ × 11 LEF		98			
8 ¹ / ₂ × 11 SEF		34			
8K SEF		85			
16K LEF					
16K SEF		12			
Other Paper Sizes		115			

0605 Staple Position: With Feed

Adjust the horizontal position of the staples when using Finisher SR5110 or Booklet Finisher SR5120.

Press [+] to move the stapling position away from the trailing edge of the sheet or [-] to move it toward the edge.

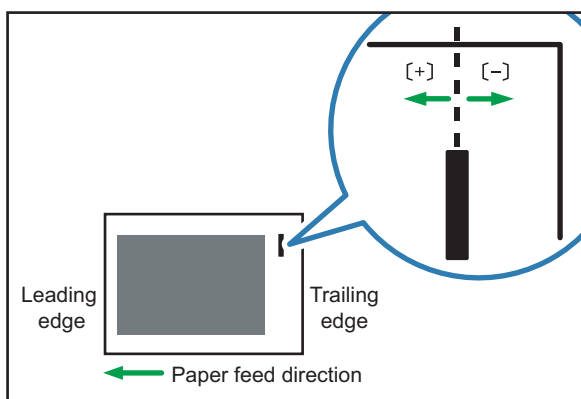

Adjustment Settings for Operators

Setting Items	Default Value	Max. Value	Min. Value	Step	Unit
A3 SEF	0.0	2.0	-2.0	0.1	mm
B4 JIS SEF					
A4 LEF					
A4 SEF					
B5 JIS LEF					
B5 JIS SEF					
11 × 17 SEF					
8 ¹ / ₂ × 14 SEF					
8 ¹ / ₂ × 13 ² / ₅ SEF					
8 ¹ / ₂ × 13 ¹ / ₂ SEF					
8 ¹ / ₂ × 11 LEF					
8 ¹ / ₂ × 11 SEF					
8K SEF					
16K LEF					
16K SEF					
Other Paper Sizes					

0606 Punch Position: Across Feed

Adjust the vertical position of the holes when using Finisher SR5110 or Booklet Finisher SR5120.

Press [+] to move the position forward (up) or [-] to move backward (down).

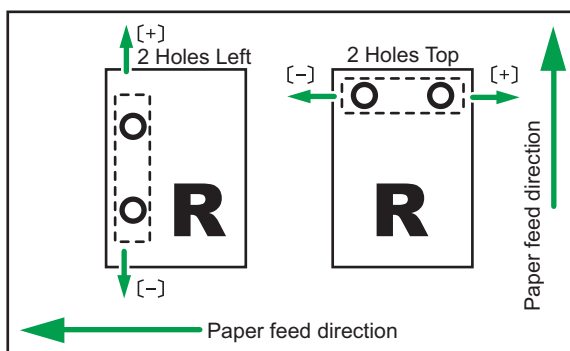

Adjustment Settings for Operators

Setting Items	Default Value	Max. Value	Min. Value	Step	Unit
2 Holes JP / EU	0.0	2.0	-2.0	0.5	mm
3 Holes US					
4 Holes EU					
4 Holes NE					
2 Holes US					

0607 Punch Position: With Feed

Adjust the horizontal position of the punch holes when using Finisher SR5110 or Booklet Finisher SR5120.

Press [+] to move the position toward the top edge (left) relative to the paper feed direction, or [-] to move it toward the bottom edge (right).

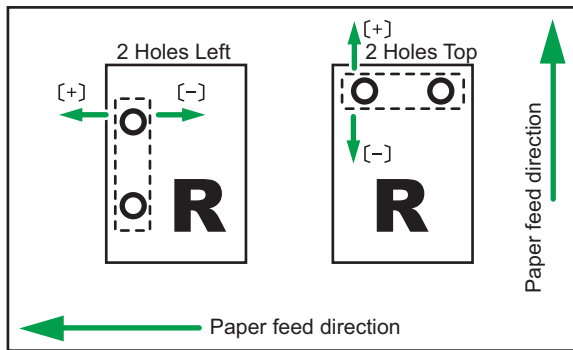

CVK008

Setting Items	Default Value	Max. Value	Min. Value	Step	Unit
2 Holes JP / EU	0.0	4.0	-4.0	0.5	mm
3 Holes US					
4 Holes EU					
4 Holes NE					
2 Holes US					

Adjustment Settings for Operators

0609 Set Number of Folds for Booklet

Specify the number of booklet folds to be performed when using Booklet Finisher SR5120. You can adjust the paper folding strength by changing the number of folds per the booklet.

When you select "0", the default value, the finisher folds the booklet according to the number of sheets in the booklet, as shown below.

- 1–6 sheets: 1 time
- 7–10 sheets: 2 times
- 11–30 sheets: 6 times

The value set here is added to the default values, which are 1, 2, and 3. Set a negative value to reduce the number of times the finisher folds booklets. Set -1, -2, or -3 to not fold booklets that have 1 to 13 sheets, 14 to 15 sheets, or 16 to 25 sheets, respectively.

Setting Items	Default Value	Max. Value	Min. Value	Step	Unit
Number of Folds for Booklet	0	6	-6	1	times

0637 Staple Tray: Rib Installed Mode to Strengthen Paper

Set the operation when the Paper Strengthening Rib is installed to Staple Tray. This function can be used with Finisher SR5110 or Booklet Finisher SR5120.

Setting Items	Values	Default Value
Setting	Off On	Off

Note

- Before you set [Staple Tray: Rib Installed Mode to Strengthen Paper] to [On], attach the paper strengthening ribs.

Adjustment Settings for Operators

0638 Accuracy Priority for Stapling

Set the accuracy priority for stapling.

Setting Items	Values	Default Value
Setting	Speed Priority Accuracy Priority	Speed Priority

0639 Accuracy Priority for Booklet

Set the accuracy priority for a booklet.

Setting Items	Values	Default Value
Setting	Speed Priority Accuracy Priority	Speed Priority

Finishing: Finisher 2

0701 Paper Alignment for Stapling: Across Feed

Adjust the width of the Staple Jogger*1 when using the staple function on Finisher SR5090 or Booklet Finisher SR5100.

Use the function to reduce the dispersion of paper orientation at a right angle due to paper size, thickness, curl and so on.

Press [+] or [-] to increase or decrease the width.

Adjustment Settings for Operators

Setting Items	Default Value	Max. Value	Min. Value	Step	Unit
A3 SEF	0.0	1.5	-1.5	0.5	mm
B4 JIS SEF					
A4 SEF					
A4 LEF					
B5 JIS SEF					
B5 JIS LEF					
11 × 17 SEF					
8 ¹ / ₂ × 14 SEF					
8 ¹ / ₂ × 13 ² / ₅ SEF					
8 ¹ / ₂ × 11 SEF					
8 ¹ / ₂ × 11 LEF					
8K SEF					
16K SEF					
16K LEF					
Other Paper Sizes					

*1 A guide for aligning output sheets when using the stapling function. The guide is located inside the finisher.

0702 Paper Alignment for Booklet: Across Feed

Adjust the width of the Staple Jogger*1 when using Booklet Finisher SR5100.
 Use the function to reduce the dispersion of paper orientation at a right angle due to paper size, thickness, curl and so on.
 Press [+] or [-] to increase or decrease the width.

Adjustment Settings for Operators

Setting Items	Default Value	Max. Value	Min. Value	Step	Unit
A3 SEF	0.0	1.5	-1.5	0.5	mm
B4 JIS SEF					
A4 SEF					
B5 JIS SEF					
11 × 17 SEF					
8 ¹ / ₂ × 14 SEF					
8 ¹ / ₂ × 13 ² / ₅ SEF					
8 ¹ / ₂ × 11 SEF					
12 × 18 SEF					
8K SEF					
Other Paper Sizes					

*1 A guide for aligning output sheets when using the stapling function. The guide is located inside the finisher.

0703 Staple Position

Adjust the vertical position of the staple (applied at an edge) when using the Finisher SR5090 or Booklet Finisher SR5100.

Press [+] to move the stapling position away from the side edge of the sheet or [-] to move it toward the edge.

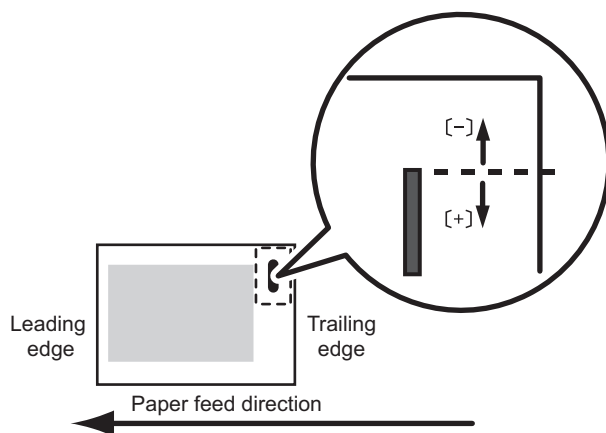

Adjustment Settings for Operators

Adjust the vertical position of the staples (dual) when using the Finisher SR5090 or Booklet Finisher SR5100.

Press [+] to move the two stapling positions away from the center and each other or [-] to move them toward each other.

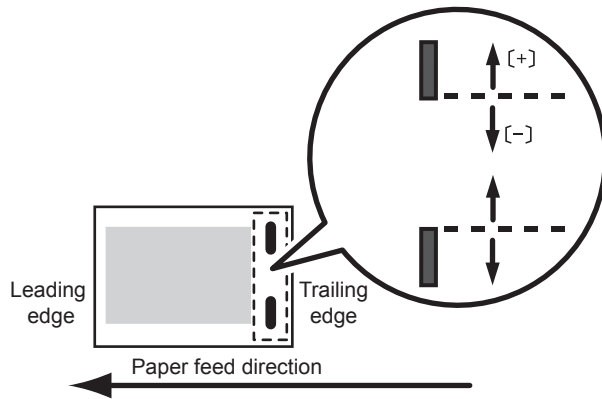

CZC215

Setting Items	Default Value	Max. Value	Min. Value	Step	Unit
A3 SEF	0.0	3.5	-3.5	0.5	mm
B4 JIS SEF					
A4 SEF					
A4 LEF					
B5 JIS SEF					
B5 JIS LEF					
11 × 17 SEF					
8 ¹ / ₂ × 14 SEF					
8 ¹ / ₂ × 13 ² / ₅ SEF					
8 ¹ / ₂ × 11 SEF					
8 ¹ / ₂ × 11 LEF					
8K SEF					
16K SEF					
16K LEF					
Other Paper Sizes					

Adjustment Settings for Operators

0704 Staple Position for Booklet

Adjust the horizontal position of the booklet staples when using Booklet Finisher SR5100. Press [+] to move the position left, or press [-] to move it right on the open booklet.

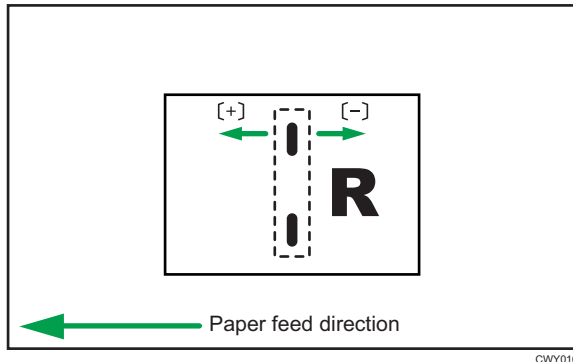

Setting Items	Default Value	Max. Value	Min. Value	Step	Unit		
A3 SEF	0.0	3.0	-3.0	0.2	mm		
B4 JIS SEF							
A4 SEF							
B5 JIS SEF							
11 × 17 SEF							
8 ¹ / ₂ × 14 SEF							
8 ¹ / ₂ × 13 ² / ₅ SEF							
8 ¹ / ₂ × 11 SEF							
12 × 18 SEF						1.8	-1.8
8K SEF						3.0	-3.0
Other Paper Sizes	1.8	-1.8					

0705 Folding Position for Booklet

Adjust the horizontal position of the folding when using Booklet Finisher SR5100. Press [+] to move the position left or press [-] to move it right on the open booklet.

Adjustment Settings for Operators

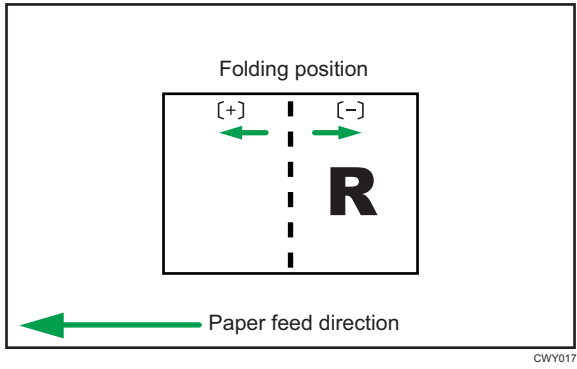

Setting Items	Default Value	Max. Value	Min. Value	Step	Unit
A3 SEF	0.0	3.0	-3.0	0.2	mm
B4 JIS SEF					
A4 SEF					
B5 JIS SEF					
11 × 17 SEF					
8 ¹ / ₂ × 14 SEF					
8 ¹ / ₂ × 13 ² / ₅ SEF					
8 ¹ / ₂ × 11 SEF					
12 × 18 SEF					
8K SEF					
Other Paper Sizes					

0706 Folding Position for Booklet: By Number of Sheets

Adjust the folding position. In left and right spread state, move to right with [+] and left with [-].

CIP Training Pro 8300 series

Adjustment Settings for Operators

Setting Items	Default Value	Max. Value	Min. Value	Step	Unit
A3 SEF: 1-5 Sheets	0.0	3.0	-3.0	0.2	mm
A3 SEF: 6-10 Sheets					
A3 SEF: 11-15 Sheets					
A3 SEF: 16 Sheets or More					
B4 SEF: 1-5 Sheets					
B4 SEF: 6-10 Sheets					
B4 SEF: 11-15 Sheets					
B4 SEF: 16 Sheets or More					
A4 SEF: 1-5 Sheets					
A4 SEF: 6-10 Sheets					
A4 SEF: 11-15 Sheets					
A4 SEF: 16 Sheets or More					
B5 SEF: 1-5 Sheets					
B5 SEF: 6-10 Sheets					
B5 SEF: 11-15 Sheets					
B5 SEF: 16 Sheets or More					
11 × 17 SEF: 1-5 Sheets					
11 × 17 SEF: 6-10 Sheets					
11 × 17 SEF: 11-15 Sheets					
11 × 17 SEF: 16 Sheets or More					

Adjustment Settings for Operators

Setting Items	Default Value	Max. Value	Min. Value	Step	Unit
8 ¹ / ₂ × 14 SEF: 1-5 Sheets	0	3.0	-3.0	0.2	mm
8 ¹ / ₂ × 14 SEF: 6-10 Sheets					
8 ¹ / ₂ × 14 SEF: 11-15 Sheets					
8 ¹ / ₂ × 14 SEF: 16 Sheets or More					
8 ¹ / ₂ × 13 ² / ₅ SEF: 1-5 Sheets					
8 ¹ / ₂ × 13 ² / ₅ SEF: 6-10 Sheets					
8 ¹ / ₂ × 13 ² / ₅ SEF: 11-15 Sheets					
8 ¹ / ₂ × 13 ² / ₅ SEF: 16 Sheets or More					
8 ¹ / ₂ × 11 SEF: 1-5 Sheets					
8 ¹ / ₂ × 11 SEF: 6-10 Sheets					
8 ¹ / ₂ × 11 SEF: 11-15 Sheets					
8 ¹ / ₂ × 11 SEF: 16 Sheets or More					
12 × 18 SEF: 1-5 Sheets					
12 × 18 SEF: 6-10 Sheets					
12 × 18 SEF: 11-15 Sheets					
12 × 18 SEF: 16 Sheets or More					
8K SEF: 1-5 Sheets					
8K SEF: 6-10 Sheets					
8K SEF: 11-15 Sheets					
8K SEF: 16 Sheets or More					
Other Paper Sizes: 1-5 Sheets					
Other Paper Sizes: 6-10 Sheets					
Other Paper Sizes: 11-15 Sheets					
Other Paper Sizes: 16 Sheets or More					

0707 Number of Sheets Align for Stapling

Specify the number of sheets to align for stapling at one time.

If too many sheets are delivered to the shift unit, the stacked sheets may not be correctly aligned due to the paper type and paper condition.

If that happens, adjust the setting to the optimal value for the paper you are using.

When the number is less, it takes more time to align and productivity may fall.

Adjustment Settings for Operators

Setting Items	Default Value	Max. Value	Min. Value	Step	Unit
A3 SEF	0	0	-1	1	sheet
B4 JIS SEF					
A4 SEF					
A4 LEF					
B5 JIS SEF					
B5 JIS LEF					
11 × 17 SEF					
8 ¹ / ₂ × 14 SEF					
8 ¹ / ₂ × 11 SEF					
8 ¹ / ₂ × 11 LEF					
8K SEF					
16K SEF					
16K LEF					
Other Paper Sizes					

0708 Number of Sheets Align for Booklet

Adjust the maximum number of prestack sheets for a booklet for each specified paper size.

Setting Items	Default Value	Max. Value	Min. Value	Step	Unit
A3 SEF	0	0	-2	1	sheet
B4 JIS SEF					
A4 SEF					
B5 JIS SEF					
11 × 17 SEF					
8 ¹ / ₂ × 14 SEF					
8 ¹ / ₂ × 13 ² / ₅ SEF					
8 ¹ / ₂ × 11 SEF					
12 × 18 SEF					
8K SEF					
Other Paper Sizes					

Adjustment Settings for Operators

Finishing: Fold

0801 Z-fold Position 1

Adjust the fold position of the end segment (S) when using the fold unit.

Press [] to increase and [] to reduce (S).

The mark ○ indicates the leading edge (relative to the paper feed direction), and the mark ● indicates the trailing edge.

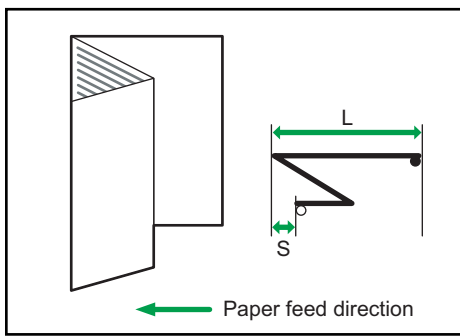

DWP561

Setting Items	Default Value	Max. Value	Min. Value	Step	Unit
A3 SEF	0.0	4.0	-4.0	0.2	mm
B4 JIS SEF					
A4 SEF					
12 × 18 SEF					
11 × 17 SEF					
8 ¹ / ₂ × 14 SEF					
8 ¹ / ₂ × 11 SEF					
8K SEF					
Other Paper Sizes					

Adjustment Settings for Operators

0802 Z-fold Position 2

Adjust the overall fold size (L) of the Z-foldout sheets when using the fold unit.

Press [+] to increase and [-] to reduce (L).

The ○ mark indicates the leading edge (relative to the paper feed direction), and the ● mark indicates the trailing edge.

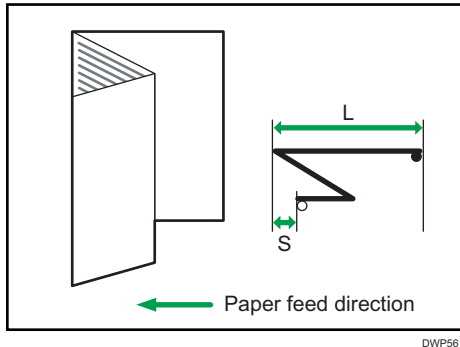

Setting Items	Default Value	Max. Value	Min. Value	Step	Unit
A3 SEF	0.0	4.0	-4.0	0.2	mm
B4 JIS SEF					
A4 SEF					
12 × 18 SEF					
11 × 17 SEF					
8 ¹ / ₂ × 14 SEF					
8 ¹ / ₂ × 11 SEF					
8K SEF					
Other Paper Sizes					

0803 Half Fold Position: 1 sheet Fold

Adjust the edge width of the half folded sheets (1 sheet fold) when using the fold unit.

Press [+] to increase and [-] to reduce (S).

This setting will be applied if the single-sheet fold function is enabled.

The ○ mark indicates the leading edge (relative to the paper feed direction), and the ● mark indicates the trailing edge.

Adjustment Settings for Operators

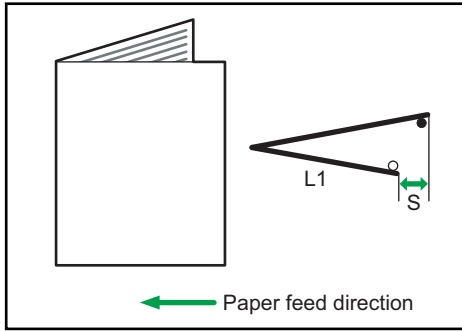

DWP562

Setting Items	Default Value	Max. Value	Min. Value	Step	Unit
A3 SEF	0.0	4.0	-4.0	0.2	mm
B4 JIS SEF					
A4 SEF					
B5 JIS SEF					
SRA3 SEF					
SRA4 SEF					
310 × 432mm SEF					
226 × 310mm SEF					
13 × 19 ¹ / ₅ SEF					
13 × 19 SEF					
13 × 18 SEF					
12 ³ / ₅ × 19 ¹ / ₅ SEF					
12 ³ / ₅ × 18 ¹ / ₂ SEF					
12 × 18 SEF					
11 × 17 SEF					
8 ¹ / ₂ × 14 SEF					
8 ¹ / ₂ × 11 SEF					
8K SEF					
Other Paper Sizes					

Adjustment Settings for Operators

0804 Half Fold Position: Multi-sheet Fold

Adjust the edge width of the half folded sheets (multi-sheet fold) when using the fold unit.

This setting will be applied if the multi-sheet fold function is enabled.

Press [+] to increase and [-] to reduce (S).

The ○ mark indicates the leading edge (relative to the paper feed direction), and the ● mark indicates the trailing edge.

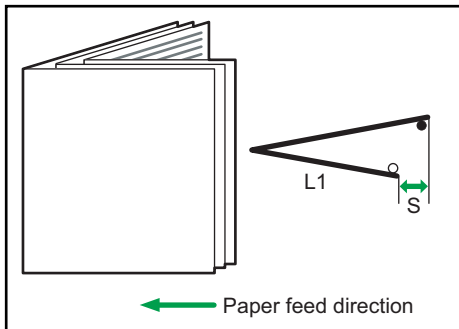

CWY007

Setting Items	Default Value	Max. Value	Min. Value	Step	Unit
A3 SEF	0.0	4.0	-4.0	0.2	mm
B4 JIS SEF					
A4 SEF					
B5 JIS SEF					
SRA3 SEF					
SRA4 SEF					
310 × 432mm SEF					
226 × 310mm SEF					
13 × 19 ¹ / ₅ SEF					
13 × 19 SEF					
13 × 18 SEF					
12 ³ / ₅ × 19 ¹ / ₅ SEF					
12 ³ / ₅ × 18 ¹ / ₂ SEF					
12 × 18 SEF					
11 × 17 SEF					
8 ¹ / ₂ × 14 SEF					
8 ¹ / ₂ × 11 SEF					
8K SEF					
Other Paper Sizes					

Adjustment Settings for Operators

0805 Letter Fold-out Position 1: 1 sheet Fold

Adjust the fold position of the bottom segment (S2) of letter foldout sheets (1 sheet fold) when using the fold unit.

Press [+] to increase and [-] to reduce (S2).

This setting will be applied if the single-sheet fold function is enabled.

The ○ mark indicates the leading edge (relative to the paper feed direction), and the ● mark indicates the trailing edge.

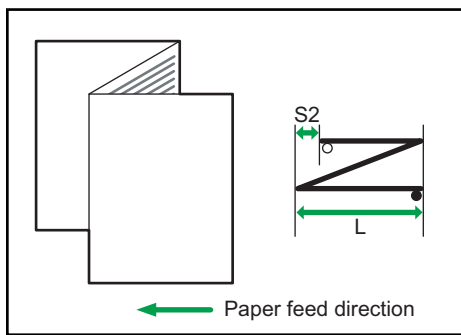

Setting Items	Default Value	Max. Value	Min. Value	Step	Unit
A3 SEF B4 JIS SEF A4 SEF	0.0	4.0	-4.0	0.2	mm
B5 JIS SEF	0.0	3.0	-3.0	0.2	mm
12 × 18 SEF 11 × 17 SEF 8 ¹ / ₂ × 14 SEF 8 ¹ / ₂ × 11 SEF 8K SEF Other Paper Sizes	0.0	4.0	-4.0	0.2	mm

Adjustment Settings for Operators

0806 Letter Fold-out Position 1: Multi-sheet Fold

Adjust the fold position of the bottom segment of letter foldout sheets (multi-sheet fold) when using the fold unit. This setting will be applied if the multi-sheet fold function is enabled.

Press [+] to increase and [-] to reduce (S2).

The ○ mark indicates the leading edge (relative to the paper feed direction), and the ● mark indicates the trailing edge.

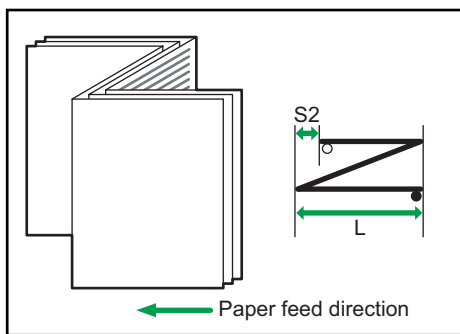

CWY008

Setting Items	Default Value	Max. Value	Min. Value	Step	Unit
B4 JIS SEF A4 SEF	0.0	4.0	-4.0	0.2	mm
B5 JIS SEF	0.0	3.0	-3.0	0.2	mm
8 ¹ / ₂ × 14 SEF 8 ¹ / ₂ × 11 SEF Other Paper Sizes	0.0	4.0	-4.0	0.2	mm

Adjustment Settings for Operators

0807 Letter Fold-out Position 2: 1 sheet Fold

Adjust the fold position of the bottom segment of letter foldout sheets (multi-sheet fold)

Adjust the overall fold size (L) of letter foldout sheets (1 sheet fold) when using the fold unit.

Press [+] to increase and [-] to reduce (L).

This setting will be applied if the single-sheet fold function is enabled.

The ○ mark indicates the leading edge (relative to the paper feed direction), and the ● mark indicates the trailing edge.

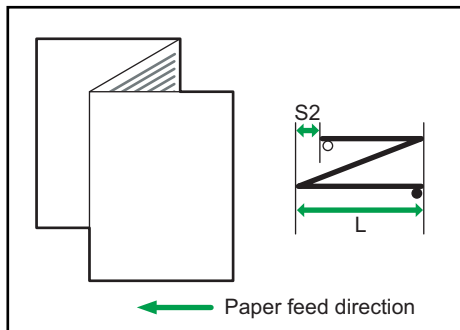

DWP563

Setting Items	Default Value	Max. Value	Min. Value	Step	Unit
A3 SEF	0.0	4.0	-4.0	0.2	mm
B4 JIS SEF					
A4 SEF					
B5 JIS SEF	0.0	3.0	-3.0	0.2	mm
12 × 18 SEF	0.0	4.0	-4.0	0.2	mm
11 × 17 SEF					
8 ¹ / ₂ × 14 SEF					
8 ¹ / ₂ × 11 SEF					
8K SEF					
Other Paper Sizes					

Adjustment Settings for Operators

0808 Letter Fold-out Position 2: Multi-sheet Fold

Adjust the overall fold size of letter foldout sheets (multi-sheet fold) when using the fold unit. This setting will be applied if the multi-sheet fold function is enabled.

Press [+] to increase and [-] to reduce (L).

The ○ mark indicates the leading edge (relative to the paper feed direction), and the ● mark indicates the trailing edge.

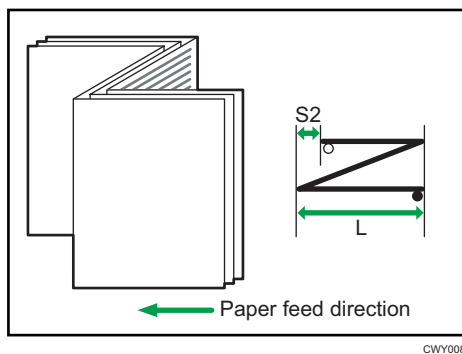

Setting Items	Default Value	Max. Value	Min. Value	Step	Unit
B4 JIS SEF A4 SEF	0.0	4.0	-4.0	0.2	mm
B5 JIS SEF	0.0	3.0	-3.0	0.2	mm
8 ¹ / ₂ × 14 SEF 8 ¹ / ₂ × 11 SEF Other Paper Sizes	0.0	4.0	-4.0	0.2	mm

0809 Letter Fold-in Position 1: 1 sheet Fold

Adjust the fold position of the bottom segment (S) of letter fold-in sheets (1 sheet fold) when using the fold unit.

Press [+] to increase and [-] to reduce (S).

This setting will be applied if the single-sheet fold function is enabled.

The ○ mark indicates the leading edge (relative to the paper feed direction), and the ● mark indicates the trailing edge.

Adjustment Settings for Operators

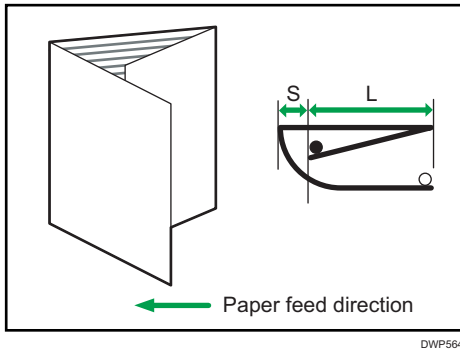

Setting Items	Default Value	Max. Value	Min. Value	Step	Unit
A3 SEF	0.0	4.0	-4.0	0.2	mm
B4 JIS SEF					
A4 SEF					
B5 JIS SEF					
12 × 18 SEF					
11 × 17 SEF					
8 ¹ / ₂ × 14 SEF					
8 ¹ / ₂ × 11 SEF					
8K SEF					
Other Paper Sizes					

0810 Letter Fold-in Position 1: Multi-sheet Fold

Adjust the fold position of the bottom segment of letter fold-in sheets (multi-sheet fold) when using the fold unit.

This setting will be applied if the multi-sheet fold function is enabled.

Press [+] to increase and [-] to reduce (S).

The ○ mark indicates the leading edge (relative to the paper feed direction), and the ● mark indicates the trailing edge.

Adjustment Settings for Operators

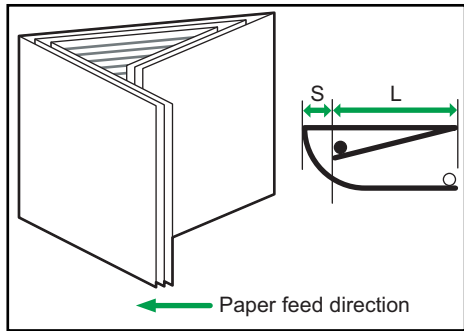

CWY009

Setting Items	Default Value	Max. Value	Min. Value	Step	Unit
A3 SEF	0.0	4.0	-4.0	0.2	mm
B4 JIS SEF					
A4 SEF					
B5 JIS SEF					
12 × 18 SEF					
11 × 17 SEF					
8 ¹ / ₂ × 14 SEF					
8 ¹ / ₂ × 11 SEF					
8K SEF					
Other Paper Sizes					

0812 Letter Fold-in Position 2: Multi-sheet Fold

Adjust the fold size when Inside 3 Folding is executed (Overlap Folding) when using the fold unit. Press [+] to increase and [-] to reduce (L).

The ○ mark indicates the leading edge (relative to the paper feed direction), and the ● mark indicates the trailing edge.

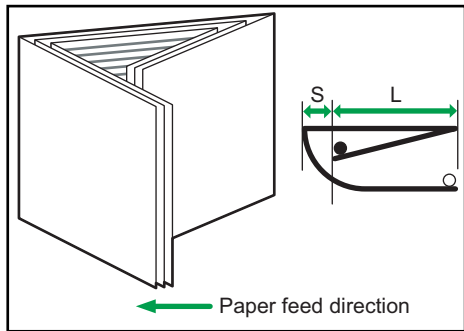

CWY009

Adjustment Settings for Operators

Setting Items	Default Value	Max. Value	Min. Value	Step	Unit
A3 SEF	0.0	4.0	-4.0	0.2	mm
B4 JIS SEF					
A4 SEF					
B5 JIS SEF			0.0		
12 × 18 SEF					
11 × 17 SEF			-4.0		
8 ¹ / ₂ × 14 SEF					
8 ¹ / ₂ × 11 SEF			0.0		
8K SEF			-4.0		
Other Paper Sizes					

0813 Double Parallel Fold Position 1

Adjust the fold position (S1) of the bottom segment 1 of double parallel-folded sheets when using the fold unit.

Press [+] to increase and [-] to reduce (S1).

The ○ mark indicates the leading edge (relative to the paper feed direction), and the ● mark indicates the trailing edge. The illustration below shows a gatefold sheet partially opened in the half-folded state.

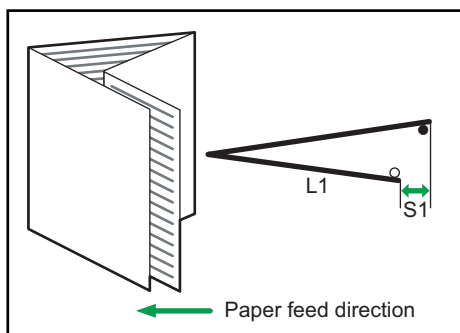

DWP565

Adjustment Settings for Operators

Setting Items	Default Value	Max. Value	Min. Value	Step	Unit
A3 SEF	0.0	4.0	-4.0	0.2	mm
B4 JIS SEF					
A4 SEF					
B5 JIS SEF					
12 × 18 SEF					
11 × 17 SEF					
8 ¹ / ₂ × 14 SEF					
8 ¹ / ₂ × 11 SEF					
8K SEF					
Other Paper Sizes					

0814 Double Parallel Fold Position 2

Adjust the fold position (S2) of the bottom segment 2 of double parallel-folded sheets when using the fold unit.

Press [+] to increase and [-] to reduce (S2).

The ○ mark indicates the leading edge (relative to the paper feed direction), and the ● mark indicates the trailing edge.

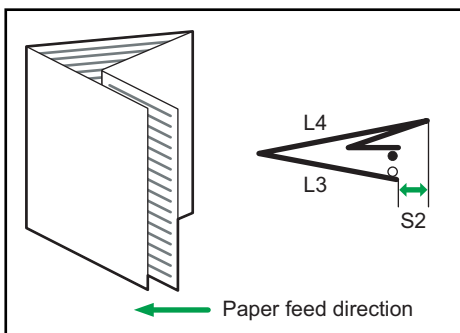

DWP566

Adjustment Settings for Operators

Setting Items	Default Value	Max. Value	Min. Value	Step	Unit
A3 SEF	0.0	4.0	-4.0	0.2	mm
B4 JIS SEF					
A4 SEF					
B5 JIS SEF					
12 × 18 SEF					
11 × 17 SEF					
8 ¹ / ₂ × 14 SEF					
8 ¹ / ₂ × 11 SEF					
8K SEF					
Other Paper Sizes					

0815 Gate Fold Position 1

Adjust the fold position (S1) of the bottom segment 1 of gatefold sheets when using the fold unit.

Press [+] to increase and [-] to reduce (S1).

The ○ mark indicates the leading edge (relative to the paper feed direction), and the ● mark indicates the trailing edge. The illustration below shows a gatefold sheet partially opened in the half-folded state.

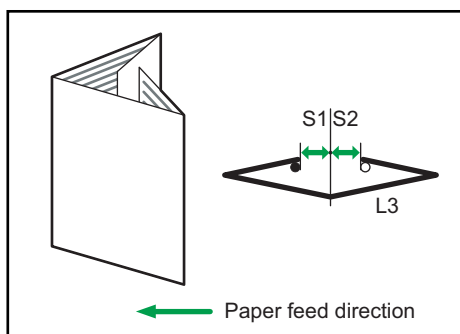

DWP567

Adjustment Settings for Operators

Setting Items	Default Value	Max. Value	Min. Value	Step	Unit
A3 SEF	0.0	4.0	-4.0	0.2	mm
B4 JIS SEF					
A4 SEF					
B5 JIS SEF					
11 × 17 SEF					
8 ¹ / ₂ × 14 SEF					
8 ¹ / ₂ × 11 SEF					
8K SEF					
Other Paper Sizes					

0816 Gate Fold Position 2

Adjust the fold position (S2) of the bottom segment 2 of gatefold sheets when using the fold unit.

Press [+] to increase and [-] to reduce (S2).

The ○ mark indicates the leading edge (relative to the paper feed direction), and the ● mark indicates the trailing edge. The illustration below shows a gatefold sheet partially opened in the half-folded state.

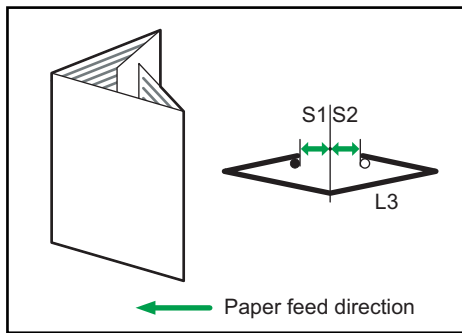

DWP567

Adjustment Settings for Operators

Setting Items	Default Value	Max. Value	Min. Value	Step	Unit
A3 SEF	0.0	4.0	-4.0	0.2	mm
B4 JIS SEF					
A4 SEF					
B5 JIS SEF					
11 × 17 SEF					
8 ¹ / ₂ × 14 SEF					
8 ¹ / ₂ × 11 SEF					
8K SEF					
Other Paper Sizes					

0817 Gate Fold Position 3

Adjust the fold position (S3) of the bottom segment 3 of gatefold sheets when using the fold unit.

Press [+] to increase and [-] to reduce (S3).

The ○ mark indicates the leading edge (relative to the paper feed direction), and the ● mark indicates the trailing edge.

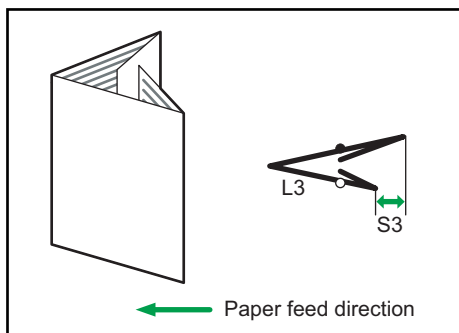

DWP568

Adjustment Settings for Operators

Setting Items	Default Value	Max. Value	Min. Value	Step	Unit
A3 SEF	0.0	4.0	-4.0	0.2	mm
B4 JIS SEF					
A4 SEF					
B5 JIS SEF					
12 × 18 SEF					
11 × 17 SEF					
8 ¹ / ₂ × 14 SEF					
8 ¹ / ₂ × 11 SEF					
8K SEF					
Other Paper Sizes					

Finishing: Stacker

1007 Maximum Stack Quantity in Stacker Tray

Specify the maximum number of sheets that can be stacked on the stacker tray. The setting applies to both the 1st and 2nd stackers.

The maximum number of sheets you can set differs depending on the size, thickness, and paper curl. Set the maximum number by specifying a ratio based on the number of sheets. Select [Large Size] when using paper whose vertical and horizontal lengths are 210 mm or longer whose area is 8¹/₂ × 11 or wider. Select [Small Size] when using other size paper.

Setting Items	Values	Default Value
Large Size	100% 75% 50% 25%	100%
Small Size	100% 75% 50% 25%	50%

Adjustment Settings for Operators

Finishing: Interposer

1101 Interposer Double Feed Detection

Set whether to detect double feed.

If this is set to [On], the machine detects double feeding and so keeps unintended blank sheets out of the delivered paper. The machine may erroneously detect double feeding when using special paper.

To prevent erroneous detection of double feeding, set this to [Off].

Setting Items	Values	Default Value
Interposer Upper Tray	Off On	Off
Interposer Lower Tray	Off On	Off

1102 Interposer Fan Setting

Set the fan operation for Interposer.

When it is [ON], air is blown to the edge of sheets to separate them in close contact.

Setting Items	Values	Default Value
Interposer Upper Tray	Auto	Auto
Interposer Lower Tray	On Off	

1103 Interposer Fan Level

Adjust the correction value for the standard value of the interposer fan level. Use [+] or [-] to increase or decrease the fan volume.

Setting Items	Default Value	Max. Value	Min. Value	Step	Unit
Interposer Upper Tray	0	90	0	10	%
Interposer Lower Tray					

RICOH
imagine. change.